

OWNER'S MANUAL 193111-095

Issued April 22, 2020

IMPORTANT: Read these instructions before installing, operating, or servicing this system.

ECLIPSE II



DO NOT DESTROY

AMETEK/PRESTOLITE POWER, TROY, OHIO 45373-1099, U.S.A.

NOTE: Information regarding obtaining additional copies of this manual is located in the Introduction chapter of this manual.

A battery charger is identified by model number. Incorporated into the model number is the ampere-hour capacity, case size, input power phase, and number of cells in battery for which charger is intended. The following example explains the basic model numbering arrangement.

Model 800 EC 3 - 18 S

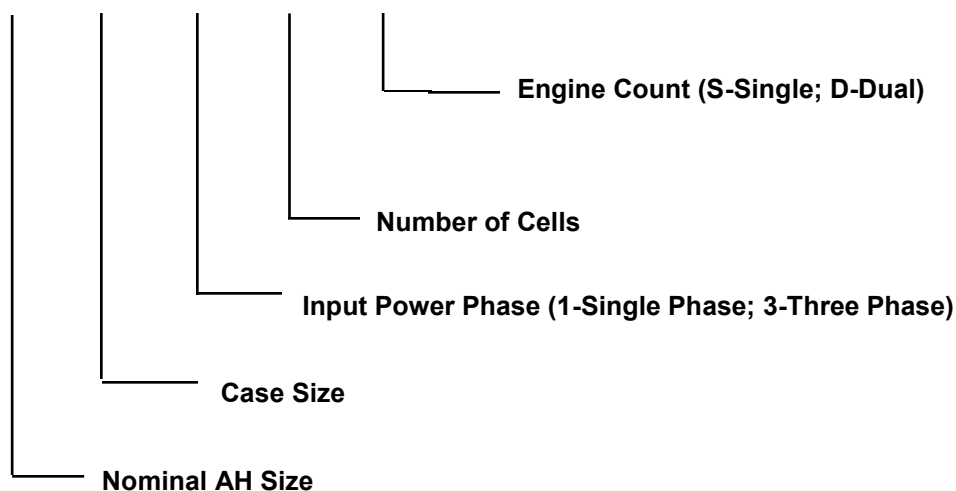

NOTE: This information is required for ordering certain replacement/service parts.

INTRODUCTION	1
How To Use This Manual	1-1
Equipment Identification	1-1
Receipt Of Equipment	1-1
SAFETY INSTRUCTIONS AND WARNINGS	2
DESCRIPTION OF EQUIPMENT	3
Operating Modes	3-1
EC2000 Control	3-2
INSTALLATION	4
Location	4-1
Environmental Characteristics	4-1
Grounding	4-1
Line Connections to Battery Charger	4-2
Charging Cable Connectors	4-3
Pre-operation Checks	4-3
Pre-Operation Changes to the Factory Control Settings	4-3
MAINTENANCE	5
OPERATION	6
Preliminary	6-1
Normal Or Daily Charge	6-1
Equalize Or Weekend Charge	6-2
Manual Stop	6-2
AC Power Fail	6-2
EC2000 CONTROL FEATURES	7
Main Features	7-1
Description of Features	7-2
EC2000 Charge Archive Function	7-5
EC2000 Charge Cycle Review Function	7-6
PROGRAMMING YOUR EC2000 CONTROL	8
Multi Amp Hour Programming	8-7
Timer Start Mode Programming	8-8
TROUBLESHOOTING	9
Troubleshooting Table	9-1
Action	9-9

DIAGRAMS

WARRANTY

This page intentionally left blank.

INTRODUCTION

How To Use This Manual

IMPORTANT: It is especially important that all charger internal components be kept clean and dry, and all electrical connections tightened. Replace any precautionary or instruction label that cannot be easily read.

To ensure safe operation, read the entire manual, including the chapter on safety instructions and warnings.

Throughout this manual, the words **WARNING**, **CAUTION**, and **NOTE** may appear. Pay particular attention to the information provided under these headings. These special annotations are easily recognized as follows:

WARNING gives information regarding possible personal injury. Warnings will be enclosed in a box such as this.

CAUTION refers to possible equipment damage. Cautions will be shown in bold type.

NOTE offers helpful information concerning certain operating procedures. Notes will be shown in italics.

Equipment Identification

The unit's identification number (specification, model, serial number) usually appears on a nameplate attached to the front panel.

Receipt Of Equipment

When you receive the equipment, check it against the invoice to make sure it is complete and inspect the equipment for possible damage due to shipping. If there is any damage, notify the carrier immediately to file a claim. Furnish complete information concerning damage claims or shipping errors to the company shown on the cover of this manual. Include all equipment identification numbers and group part numbers (if any) as described above along with a full description of the parts in error.

Move the equipment to the site of installation before uncrating. Use care to avoid damaging the equipment when using bars, hammers, etc., to uncrate the unit.

Additional copies of this manual may be purchased by contacting the company shown on the cover of this manual. Include the Owner's Manual number and equipment identification numbers.

This page intentionally left blank.

SAFETY INSTRUCTIONS AND WARNINGS

FOR OPERATION OF BATTERY CHARGING EQUIPMENT

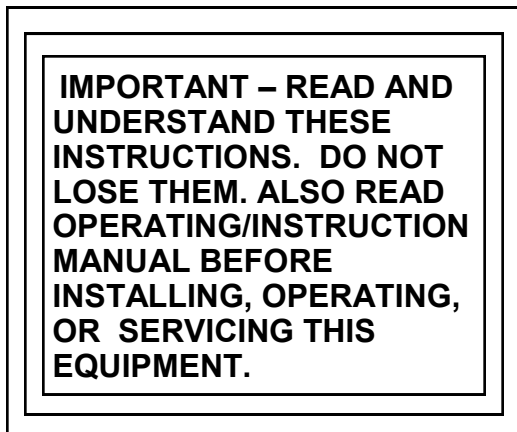

A. General

Battery charging products can cause serious injury or death, or damage to other equipment or property, if the operator does not strictly observe all safety rules and take precautionary actions.

Safe practices have developed from past experience in the use of charging equipment. These practices must be learned through study and training before using this equipment. Anyone not having extensive training in battery charging practices should be taught by experienced operators.

Only qualified personnel should install, use, or service this equipment.

B. Shock Prevention

Bare conductors, or terminals in the output circuit, or ungrounded, electrically-live equipment can fatally shock a person. To protect against shock, have competent electrician verify that the equipment is adequately grounded and learn what terminals and parts are electrically HOT.

The body's electrical resistance is decreased when wet, permitting dangerous current to flow through the body. Do not work in damp area without being extremely careful. Stand on dry rubber mat or dry wood and use insulating gloves when dampness or sweat cannot be avoided. Keep clothing dry.

1. Installation and Grounding of Electrically Powered Equipment – Electrical equipment must be installed and maintained in accordance with the National Electrical Code, NFPA 70, and local codes. A power disconnect switch must be located at the equipment. Check nameplate for voltage and phase requirements. If only 3-phase power is available, connect *single-phase* equipment to only two wires of the 3-phase line. **DO NOT CONNECT** the equipment grounding conductor (lead) to the third live wire of the 3-phase line as this makes the equipment frame electrically HOT, which can cause a fatal shock.

If a grounding lead (conductor) is part of the power supply cable, be sure to connect it to a properly grounded switch box or building ground. If not part of the supply cable, use a separate grounding lead (conductor). Do not remove a ground prong from any plug. Use correct mating receptacles. Check ground for electrical continuity before using equipment.

The grounding conductor must be of a size equal to or larger than the size recommended by Code or in this manual.

2. Charging Leads – Inspect leads often for damage to the insulation. Replace or repair cracked or worn leads immediately. Use leads having sufficient capacity to carry the operating current without overheating.
3. Battery Terminals – Do not touch battery terminals while equipment is operating.
4. Service and Maintenance – Shut OFF all power at the disconnect switch or line breaker *before* inspecting, adjusting, or servicing the equipment. Lock switch OPEN (or remove line fuses) so that the power cannot be turned ON accidentally. Disconnect power to equipment if it is to be left unattended or out of service.

Disconnect battery from charger.

Keep inside parts clean and dry. Dirt and/or moisture can cause insulation failure. This failure can result in high voltage at the charger output.

C. Burn and Bodily Injury Prevention

The battery produces very high currents when short circuited, and will burn the skin severely if in contact with any metal conductor that is carrying this current. Do not permit rings on fingers to come in contact with battery terminals or the cell connectors on top of the battery.

Battery acid is very corrosive. Always wear correct eye and body protection when near batteries.

D. Fire and Explosion Prevention

Batteries give off explosive flammable gases which easily ignite when coming in contact with an open flame or spark. Do not smoke, cause sparking, or use open flame near batteries. Charge batteries only in locations which are clean, dry, and well ventilated. Do not lay tools or anything that is metallic on top of any battery. All repairs to a battery must be made only by experienced and qualified personnel.

E. Arcing and Burning of Connector

To prevent arcing and burning of the connector contacts, be sure the charger is OFF before connecting or disconnecting the battery. (If the charger is equipped with an ammeter, the ammeter should not indicate current flow.) Always connect battery before turning charger ON.

F. Medical and First Aid Treatment

First aid facilities and a qualified first aid person should be available for each shift for immediate treatment of electrical shock victims.

EMERGENCY FIRST AID: Call physician and ambulance immediately. Use First Aid techniques recommended by the American Red Cross.

DANGER: ELECTRICAL SHOCK CAN BE FATAL. If person is unconscious and electric shock is suspected, do not touch person if he or she is in contact with charging leads, charging equipment, or other live electrical parts. Disconnect (open) power at wall switch and then use First Aid. Dry wood, wooden broom, and other insulating material can be used to move cables, if necessary, away from person. IF BREATHING IS DIFFICULT, give oxygen. IF NOT BREATHING, BEGIN ARTIFICIAL BREATHING, such as mouth-to-mouth. IF PULSE IS ABSENT, BEGIN ARTIFICIAL CIRCULATION, such as external heart massage.

IN CASE OF ACID IN THE EYES, flush very well with clean water and obtain professional medical attention immediately.

G. Equipment Warning Labels

Inspect all precautionary labels on the equipment. Order and replace all labels that cannot be easily read.

DESCRIPTION OF EQUIPMENT

The basic charging circuit is the mosfet inverter high frequency-type with isolating transformer (s). This design regulates charging current by allowing the battery to determine its own charge cycle rate in accordance with its state of discharge. It provides a constant current-constant voltage-constant current (IEI) charge that eliminates the possibility of over-charging, even with line voltage variations of $\pm 10\%$ and allows the battery to finish at the proper current regardless of battery age or gravity type.

The Eclipse II provides battery charging over a wide range of environmental conditions. The charger will precisely charge your battery based on battery temperature, type, and size; by automatically adjusting its own output charge characteristic within the power limits of the chargers power circuit.

When applied with the Prestolite Power optional Battery Identification Module (BID), the Eclipse II identifies a battery selected for charging at the time of connection and adjusts its output for that specific battery. During the charge cycle, or duration of connection, the Eclipse II continuously monitors the battery's temperature via the BID and adjusts its output to match the battery temperature as it changes throughout the charge cycle.

Upon connection of the battery, the Eclipse II reads the information programmed into the BID and identifies the battery's AH rating, cell size, type of construction, electrolyte temperature, and programmed method of charge and adjusts its output curve based on this information.

The Eclipse II is internally protected against overload and short circuits by both input and output fusing, plus Prestolite's unique *curve monitoring circuit* periodically measures the output curve to ensure that the voltage and current are within the limits set at the factory.

Charger Control

The EC2000 is the standard charge control for the Eclipse II. It utilizes either a voltage/time (VT) charge termination or a patented dV/dT charge termination technique which eliminates excessive gassing returning approximately 107% of the amp hours removed from the battery. Features of the EC2000 Control include auto start/stop, manual equalize, manual stop, back-up timer protection, two charge termination methods, manual or automatic (with optional BID module) battery temperature compensation, AC power fail recovery, selectable output profiles, and charge cycle data archiving.

The backlit 2x20 LCD display and four bright LEDs on the front panel indicate the status of a normal charge cycle. The "80% Charged" LED will light when the battery current is reduced to approximately 8.2 amps per 100 AH of battery rating. The battery voltage at the 80% charged point will vary with charge profile setting and/or manual or automatic temperature settings. The "Charge Complete" LED will light only if the battery has completed the charge cycle and is ready for use. All four LEDs will flash if the charger terminates a charge prematurely. See the Troubleshooting chapter of this manual to determine the cause of the fault. The "Equalize" LED will light solid when an equalize charge is requested by pressing the equalize push button. The "Equalize" LED will flash when the charger is equalizing the battery.

WARNING: Do not connect a battery to this charger if any lamp is lit. Do not disconnect a battery from this charger while a charge is in progress. Otherwise, damage to charger, arcing and burning of connector parts or a battery explosion may result. Batteries produce explosive gases. Keep sparks, flame, and cigarettes away. Ventilate when charging in an enclosed area. Always shield eyes when working near batteries.

This page intentionally left blank.

INSTALLATION

Location

For best operating characteristics and longest unit life, take care in selecting an installation site. Avoid locations exposed to high humidity, dust, high ambient temperature, or corrosive fumes. Moisture can condense on electrical components, causing corrosion or shorting of circuits (especially when dirt is also present).

Adequate air circulation is needed at all times in order to assure proper operation. Provide a minimum of 12 inches of free air space both sides of the unit. Make sure that ventilation openings are not obstructed.

Always remove the charger shipping skid from the unit before installation. The charger must be installed over a noncombustible surface such as concrete or metal. Keep the charging area clear of all combustible material such as wood, paper, and cloth. When moving the charger after the packing skid and box have been removed, make sure that lifting forks do not damage the charger panels or cables.

WARNING: SPARKS OR MOLTEN METAL falling through open bottom can cause fire or explosion.

- Install over noncombustible material such as concrete or metal.
- Keep charging area clear of combustible material.

Environmental Characteristics

Operating Characteristics	0°C to 40°C (32°F to 104°F)
Operating Altitude	To 2000 Meters (6562 Feet)
Operating Humidity	80% up to 31°C, decreasing to 50% at 40°C, non-condensing
	80% up to 88°F decreasing to 50% at 104°F, non-condensing

Grounding

The frame of the power source must be grounded for personnel safety. Where grounding is mandatory under state or local codes, it is the responsibility of the user to comply with all applicable rules and regulations. Where no state or local codes exist, it is recommended that the National Electrical Code be followed.

In addition to the usual function of protecting personnel against the hazard of electrical shock due to fault in the equipment, grounding serves to discharge the static

electrical charges which tend to build up on the surfaces of equipment. These static charges can cause painful shock to personnel, and can lead to the erroneous conclusion that an electrical fault exists in the equipment.

If a charger is to be connected to the AC power supply with a flexible jacketed cable, one having a separate grounding conductor should be used. When included in cable assembly, grounding conductor will be green, green with a yellow stripe, or bare. When connecting input power to charger (as instructed in Line Connection to Battery Charger section of this manual), connect grounding conductor to equipment grounding terminal (identified by symbol ) , taking care to make a good electrical connection. Connect other end of grounding conductor to the system ground.

If, for any reason, an input cable which does not include a grounding conductor is used, the equipment must be grounded with separate conductor. Minimum size and color coding requirements must be in accordance with any applicable state or local code, or the National Electrical Code.

If metallic armored cable or conduit is used, the metal sheathing or conduit must be effectively grounded as required by state or local code, or the National Electrical Code.

If a system ground is not available, the charger frame must be connected to a driven ground rod (at least 8 ft [2438 mm] long), or to a water pipe that enters the ground not more than 10 ft (3048 mm) from the charger. A grounding conductor must be connected to the rod or pipe in a manner that will assure a permanent and effective ground. The conductor must be sized in accordance with any applicable state or local code, or by the National Electrical Code. If in doubt, use the same size conductor as is used for the conductors supplying power to the charger.

WARNING: ELECTRIC SHOCK HAZARD – Under no circumstance should you use a grounding conductor with a current carrying capacity less than the ampere rating shown in Table 4-1.

LINE AMPS	DISCONNECT SWITCH *	BRANCH FUSE SIZE (AMPERES)	COPPER CABLE SIZE AWG **	
			POWER	GROUND
0-2.5	30A	5	No. 14	No. 14
2.6-4.5	30A	7	No. 14	No. 14
4.6-7.5	30A	10	No. 14	No. 14
7.6-12	30A	15	No. 14	No. 14
12.1-16	30A	20	No. 12	No. 12
16.1-18	30A	25	No. 10	No. 10
18.1-22	30A	30	No. 10	No. 10
22.1-24.5	60A	35	No. 8	No. 10
24.6-32.5	60A	40	No. 8	No. 10
32.6-40	60A	50	No. 8	No. 10
40.1-45	60A	60	No. 6	No. 10
45.1-57.5	100A	80	No. 4	No. 8
57.6-78	100A	100	No. 2	No. 8
78.1-102.5	200A	125	No. 2	No. 6
102.6-135	200A	150	No. 1/0	No. 6

Table 4-1 Recommended AC Input and Branch Fusing

The above table (Table 4-1) is based on 75°C (167°F) rated conductors and 40°C (104°F) ambient temperatures. Refer to National Electrical Code (2008) Tables 310-16 corrected to 40°C (104°F).

* For 115, 208, and 230-volt lines, use 250-volt disconnect switch.
 For 440-480, 575-volt lines, use 600-volt disconnect switch.

** Two conductors and ground conductor required for single phase.
 Three conductors and ground conductor required for three phase.

Recommended minimum size of grounding conductors (based on National Electrical Code 2008 – Table 250-95).

Line Connections to Battery Charger

Follow local code requirements if different than instructions in this manual.

1. Turn charger OFF.
2. Be sure charger is connected correctly for available line voltage as instructed above.
3. On charger nameplate, note the AC input amperes corresponding to the line voltage to which charger is to be connected. Use that ampere value to select the proper disconnect switch, fuse, and power cable sizes from Table 4-1.
4. Route AC power input cable in through knockout provided in the charger cabinet. Securely fasten cable wires to a power input terminal inside charger. Refer to Grounding section of this manual for proper connection of grounding conductor. (The lower access panel will have to be removed to provide access to terminal block.)
5. With disconnect switch (on AC input power line)

in “OPEN” or “OFF” position, connect power cable coming from charger, to the switch. Install fuses in switch.

Special Considerations—Generators and Backup Power Systems

On site power generation and backup power systems create special considerations both because of the power quality itself and also the manner in which the load is transferred between mains and backup (and reversion to mains). If this installation will incorporate either on-site generation or some other form of back up power, please consult AMETEK Engineering for a review of the planned system prior to implementation. AMETEK Engineering will review the system specifications and make a determination as to whether any changes would be required in order to provide coverage under the standard warranty.

Charging Cable Connectors

If connectors are already attached to charging cables, make sure that they are attached so that positive charger polarity will connect to positive battery terminal.

If connectors must be attached to charging cables, follow instructions supplied with connectors.

CAUTION: Make sure connectors are securely attached to cables (good solder joint or well tightened set screws, whichever is applicable). Be certain that positive charger cable will connect to positive battery terminal. If necessary, trace cables into charger to determine polarity. The use of a DC voltmeter may show polarity. Improper connections will “blow” output fuse and may cause other damage.

Note: If this charger is equipped with certain optional features, the connector attaching procedure may be modified. Refer to OPTIONS chapter of this manual for details.

Pre-operation Checks

1. Inspect charger thoroughly for damage; loose screws, nuts, or electrical connections.

WARNING: ELECTRICAL SHOCK HAZARD – Before inspecting or cleaning inside cabinet, turn OFF and remove fuses of disconnect switch (supplying AC power to charger) and disconnect battery.

2. Remove all special tags that are tied to charger. Keep tags with this manual for future reference. Leave all precautionary and instruction labels in place on charger. Carefully read and follow instructions on all tags and labels. Make sure all labels remain visible to anyone operating charger.
3. Make sure all charger cabinet panels are fastened in place, to assure proper flow of ventilating air through cabinet.

Pre-Operation Changes To The Factory Control Settings

Typically few changes are required to be made if the amp hour rating is sized to the battery and the voltage rating is equal to or greater than the battery. However, in some applications, some changes to the programmable control settings may be desirable. The most common changes are listed below:

TIME Factory Setting for Time is Eastern Standard. (see Programming the EC2000).

MAX BATTERY TEMPERATURE Factory Setting is 150° F (see Programming the EC2000).

NOTE: It is advisable to check the day of the week, date, month, and year for accuracy

AUTO EQUALIZE Factory setting is ON (see Programming the EC2000).

AUTO EQUALIZE TYPE Factory setting is by Cycle (see Programming the EC2000).

AUTO EQUALIZE COUNT Factory setting is 05 (see Programming the EC2000).

Other functions are available for programming the EC2000 to meet your specific charging needs. Programming these functions is described in the Programming Your EC2000 chapter of this manual.

MAINTENANCE

WARNING: ELECTRICAL SHOCK HAZARD — Before inspecting or cleaning inside cabinet, turn OFF and remove fuses of disconnect switch (supplying AC power to charger) and disconnect battery.

Inspection And Cleaning

For uninterrupted, satisfactory service from this charger, it's necessary to keep unit clean, dry, and well ventilated. At least every three months, or more often as necessary, wipe and blow out all dirt from unit's interior components, with clean, dry air of not over 25 psi (172 kPa) pressure. Use a hand bellows if compressed air isn't available.

If the unit is equipped with a fan, be sure to check for proper unrestricted operation. The fan should operate anytime a discharged battery is connected.

Check and tighten all electrical connections as necessary to eliminate unnecessary losses and to avoid subsequent trouble from overheating or open circuits. Check for broken wiring or damaged Insulation on wiring.

WARNING: ELECTRICAL SHOCK HAZARD — Failure to keep internal parts clean and dry may allow transformer (s) to short out, causing secondary circuits to carry dangerously high voltage.

Be sure to replace all charger cabinet panels after any servicing, to assure proper flow of cooling air through unit and to protect internal components.

WARNING: ELECTRICAL SHOCK HAZARD — All cabinet panels must be replaced to protect personnel from contact with hazardous voltages.

Lubrication

None required.

Fuse Replacement

The output silicon diodes in this charger are protected by a "fast-clearing" type fuse.

CAUTION: The use of any other type fuse besides the "fast-clearing" type may cause damage to silicon diodes.

OPERATION

The operating procedure given here explains the operation of a Prestolite Eclipse II equipped with the Prestolite EC2000 control.

NOTE: If this charger is equipped with certain optional features, the operating procedure may be modified. Refer to Options chapter of this manual for details. Options not covered in this chapter will be described on separate "addendum" sheets enclosed with the manual.

Preliminary

1. Make sure that charger is installed and grounded as instructed in this manual.
2. Turn on main fused disconnect switch that supplies AC power to charger.
3. Maintain electrolyte level in batteries to be charged, as instructed by battery manufacturer. The volume of electrolyte will expand during the charge. Therefore, to avoid overfilling, do not add water until the battery has received at least an 80% charge. This will usually be reached at the time gassing starts.

Normal or Daily Charge

(For batteries with ampere-hour capacity within the range shown on charger nameplate)

1. Insure that battery size matches the charger and/or charger setting. (Number of cells is equal to or less than the charger nameplate rating and ampere-hour capacity is within charger nameplate rating.)
2. Securely engage the battery and charger connectors.
3. The charger will display READING BID and update the progress bar (2 to 7 seconds) as the data is read into the charger.
4. After a short delay, the charger will turn on and the "Charge in Progress" LED will light. The alphanumeric display will indicate the cell size and amp hour settings for the upcoming charge cycle. Then it will display current charging cycle information. "Verifying Battery" may appear for several minutes if the multi-cell mode is on.
5. The "80% Charged" LED will light when the battery has reached the gassing point.
6. When the charge termination point is reached, the charger will turn off and the "Charge Complete" LED will be lit. If an equalize charge has been selected,

the "Equalize" LED will be lit.

NOTE: To disconnect battery from charger before charge is complete, press the "Stop" key on the charger control panel.

NOTE: While not normally required, the charging rate may be adjusted to compensate for unusual ambient temperature, age of battery, etc. Refer to items 33 through 42 in Programming Your EC2000 chapter of this manual.

WARNING: EXPLOSION HAZARD
- Do not connect or disconnect a battery unless the "Charge in Progress" LED is off; otherwise, damage to charger, arcing and burning of connector parts or a battery explosion may result (batteries produce explosive gases). Keep sparks, flame, and cigarettes away. Ventilate when charging in an enclosed area. Always shield eyes when working near batteries. Disconnect battery if charger is to be turned off for prolonged periods of time.

Equalize or Weekend Charge

Batteries may need periodic equalizing to correct for inequalities between cells that result from daily or frequent cycling. An equalizing charge should be given if any of the following conditions exist:

1. The specific gravity of any cell at the end of charge is 20 points less than the average.
2. The on-charge voltage of any cell at the end of charge is 20 MV less than the average.
3. The battery has been stored for 30 days.
4. A large volume of water has been added.

When the equalize mode is desired, follow the operation outlined for a normal charge and press EC2000 "Equalize" key to set the charge control for an Additional 3 hours more than required for a normal charge. The charge is complete when charge control automatically lights the "Charge Complete" LED.

NOTE: The EC2000 is shipped from the factory set to the Auto Equalize by Cycle mode, and will automatically provide an equalize charge every 5 complete cycles.

Manual Stop

To stop any charge cycle before charge complete, press the "Stop" key.

WARNING: Do not connect a battery to this charger if any lamp is lit. Do not disconnect a battery from this charger while a charge is in progress. Otherwise, damage to charger, arcing and burning of connector parts or a battery explosion may result. Batteries produce explosive gases. Keep sparks, flame, and cigarettes away. Ventilate when charging in an enclosed area. Always shield eyes when working near batteries.

AC Power Fail

The EC2000 Control will resume the charge where it left off when the AC power failure occurred, virtually

unaffected charge time.

As power is returned, if a charge cycle was in progress, the display may show "ACFAIL RESTART". The charger is staggering the restart based on cycle run times. This will prevent multiple chargers from restarting all at once, minimizing peak restart power.

NOTE: If a battery is disconnected from the charger during an AC power failure and discharged, reconnecting it or any other battery may result in an incomplete charge cycle.

WARNING: ELECTRICAL SHOCK HAZARD – Before checking electrical components, turn off and remove fuses or disconnect switch (supplying AC power to charger) and disconnect battery.

Abnormal Shutdowns

1. Manual Stop
If the manual stop key is pressed during the charge cycle, the charger will shutdown. All 4 LEDs will be flashing and the display will read "Manual Stop Fault".
2. Back-Up Timer Shutdown
The standard EC2000 Control has two back-up timers. The charger will shutdown and "Backup timer" will be displayed if 9 hours has passed since the start of a charge cycle and the battery has not reached gassing voltage (80% charged), or if 4 hours has passed since the battery has reached gassing voltage and a DV/DT charge termination has not occurred.
3. Battery Disconnect Shutdown
If a battery is disconnected from the charger during a charge cycle, the charger will be shut down. All LEDs will be off.

- | | |
|---|---|
| <p>4. Low Current Shutdown
If the charger output falls below a predetermined level, a low current shutdown will occur. All 4 LEDs will be flashing and the display will read "Low Current Fault".</p> <p>5. Curve Error Shutdown
If the charger output becomes uncontrolled and falls above or below the proper level for predetermined period of time, the charger will shutdown. All 4 LEDs will flashing and the display will read "Curve Error Fault".</p> <p>6. Overtemperature Shutdown
If the charger internal temperature exceeds a predetermined limit, the charger will shut down. All 4 LEDs will be flashing and the display will read "Overtemperature".</p> <p>7. Didt Shutdown
After the 80% charged point, if the output current begins to rise for more than a predetermined time period, the charger will be shutdown. All 4 LEDs will be flashing and the display will read "Didt Fault".</p> <p>8. Low Voltage Shutdown
If a battery on charge does not reach a minimum on charge voltage in a predetermined period of time, the charger will be shutdown. All 4 LEDs will be flashing and the display will read "Low Voltage Fault".</p> <p>9. High Amp Hour Returned Shutdown
If the cycle amp hours returned exceed the BID AH</p> | <p>setting or charger maximum AH rating for a predetermined amount, the charger will shutdown. All 4 LEDs will be flashing and the display will read "High Amp Hour Fault".</p> <p>10. Phase Error Shutdown
If the charger control detects a problem with the unit's input power, the charger will shutdown. All 4 LEDs will be flashing and the display will read "Phase Error".</p> |
|---|---|

20. "Cell Forming" Feature (Programmable from 0-30 Cycles)
21. Programmed Features and Archive Data maintained for a minimum of 10 Years
22. Charge Cycle Data and Time-of-Day/Date maintained for a minimum of 10 Years
23. 6 Programmable Start Modes
 - Automatic Start (2 Second Delay)
 - Push-To-Start
 - Delayed Start
 - Time-of-Day Start
 - Time-of-Day Blockout
 - Timer Mode
24. Programmable Manual Override of Start Modes
25. User Programmable Password
26. Automatic Equalize By Number of Charger or BID Cycles, Day of Week
27. Programmable Cool Down Time
28. Staggered Start on ACFAIL Recovery

Description of Features

Multi-Voltage Charging — The Eclipse II with EC2000 Control provides the capability to charge batteries of different cell sizes. With the Multi-Cell Mode ON, the charger automatically selects the proper output voltage. A 24 cell Eclipse II will safely charge 24, 18, 12, 9, and 6 cell batteries. An 18 cell Eclipse II will safely charge 18, 12, 9, and 6 cell batteries. A 12 cell Eclipse II will safely charge 12, 9, and 6 cell batteries.

Fixed mode operation can be selected by programming Multi-Cell mode to OFF. In this mode the charger will charge only batteries of the cell size programmed into the Fixed-Cell size function.

If the battery is equipped with Prestolite BID Module, the Multi-Cell ON or OFF function will be overridden and the charger will charge the battery if it is within the charger output rating.

Multi-Ampere-Hour Charging — The Eclipse II with EC2000 Control provides the capability of charging batteries of different cell sizes at the proper charge rates. Fixed Mode can be selected by programming an amp hour rating into the Fixed AH size function that is less than the charger ampere-hour nameplate rating. The output current will be adjusted to deliver current at the proper rate.

If the battery is equipped with a Prestolite BID Module, the Multi-Ampere-Hour function will be overridden and the charger will charge the battery at the rate programmed into the BID Module (BID Module programming is performed at the factory based on information provided by the customer) if it is within the charger output rating. If the BID and battery ampere-hour rating are greater than the charger rating, the charger will charge the battery at the nameplate amp hour rating.

Multi-AH Programming Feature – The Multi-AH Programming Feature allows the control to be programmed to charge different voltage batteries with the AH rates and curve types that have been programmed for that battery voltage. When a battery is connected, the control automatically senses the battery voltage and sets the charge curve and charging rates to the level that has been programmed.

If the battery is equipped with a Prestolite BID Module, the Multi-Ampere-Hour function and Multi-AH Programming will be overridden and the charger will charge the battery at the rate programmed into the BID Module (BID Module programming is performed at the factory based on information provided by the customer) if it is within the charger output rating. If the BID and battery ampere-hour rating are greater than the charger rating, the charger will charge the battery at the nameplate amp hour rating.

Temperature Compensation — The Eclipse II with EC2000 Control is capable of modifying the output voltage to compensate for ranges of battery electrolyte temperatures from 32 to 132 degrees F. Because the 80% percent point is based on reaching a point on the charge curve rather than a single voltage, it is automatically adjusted with the output voltage.

CAUTION: Consult your batteries manufacturer for the recommended maximum battery temperature for your battery.

When the battery is equipped with a Prestolite BID module, the charger automatically reads the battery temperature throughout the charge cycle and adjusts the output voltage to match the battery temperature.

Manual adjustment of the charger output voltage to match the temperature of the battery is performed by programming the proper battery electrolyte temperature into the Fixed Battery Temperature function (BID readings automatically override the Fixed Battery Temperature setting).

Max Battery Temperature—The EC2000 monitors the battery temperature throughout the charge cycle. Programming the MAX BATT TEMP setting of the control to the desired maximum battery temperature will cause the charger to shut down if the battery on charge is equipped with a BID and the temperature exceeds the set point. It will wait until the battery temperature has decreased to 5 degrees C below the set point before restarting the charge cycle.

Charge Termination — The EC2000 utilizes a patented proportional time DV/DT technique in order to determine the charge termination point. This technique returns approximately 107% of the amp hours removed from a battery (regardless of the state of discharge) and prevents variations in the incoming AC line voltage from affecting the amount of Energy returned to the battery. The minimum time required for a DV/DT charge termination on the EC2000 Control is fifteen minutes. The EC2000 Control can be programmed to utilize a voltage-time charge termination technique. If the DV/DT charge termination is disabled, the control will terminate the charge cycle four hours after the battery reaches the “80% Charged” point.

Alphanumeric Display — A backlit liquid crystal (LCD) 2x20 character display is standard on the EC2000 Control. The characters are .2 inches tall, making the information on the digital display legible at distances exceeding five feet. Plain English and easy to understand abbreviations are used to indicate charge status output current and voltage and other functions including; archive information, review information, programming information, fault information, and operating status. A blank display is utilized for AC power fail indication.

Status Display LEDs — The “Charge In Progress” LED (Amber) is illuminated whenever the charger is flowing current to the battery. There are four status LEDs provided to indicate the present operating status of the charger and battery (see Figure 7-1). A lamp test feature is provided. See [Review of Charge Cycle](#) feature.

Review of Charge Cycle — When the charge cycle is in progress or has been terminated, either by the EC2000 Control or the operator, the charge cycle history can be automatically read out by pressing the “Cycle Review” key. After displaying the information from memory, the unit will return to the normal (previous) display.

All status LEDs will be illuminated during the review of function number one, thus providing a lamp test feature. Nine functions are displayed during a standard review. If the charger is idle, the information in all 58 review functions can be displayed. See the [EC2000 Charge Cycle Review Feature](#) section in this chapter. A single item can be selected by pressing the appropriate labeled key. This feature

can greatly aid in the analysis of charge data and in situations where troubleshooting is required. See the [Troubleshooting](#) chapter in this manual.

Automatic or Push-to-Start Operation — In the automatic start mode, the charger will start 5-15 seconds after the battery is connected. The alphanumeric display will display “READING BID” and then display upcoming cycle information. In the push-to-start mode, the charger will not start the charge cycle until the “Enter” key is pressed. “Ent to Start Charge” will be displayed on battery connect when this feature has been selected.

Manual or Automatic Equalize — An equalize charge is a prolonged charge cycle (by 3 hours) used to correct any inequalities of voltage and specific gravity which may have developed between the cells during service. EC2000 Controls are shipped from the factory with the automatic equalize feature enabled. This mode of operation is indicated in the full Review “AUTO EQ. ON” function. There are three modes of automatic equalize. See the [Automatic Equalize](#) section in this chapter for further details. When the automatic equalize feature is active, the “Equalize” key on the front panel is disabled. When automatic equalize is disabled, an equalize charge is requested by pressing the “Equalize” key on the front panel of the EC2000 Control during countdown or after the charge cycle has started. If this key is pressed again during the charge cycle, the equalize request will be canceled if the equalize period has not begun.

Fault Lockout Operation — In the normal operating mode (No fault lock-out), if an abnormal shutdown occurs, disconnecting and reconnecting the battery will clear the fault and the EC2000 will restart the charge cycle as programmed. If an abnormal shutdown occurs with the fault lock-out feature enabled, disconnecting and reconnecting a battery will not clear the fault condition. The alphanumeric display will display fault lockout, and the status LEDs will continue to flash even with no battery connected to the charger until the fault condition is cleared. The “Enter” key will clear the fault if it is pressed while a battery is not connected to the charger.

One Part Number Control — The standard EC2000 Control is user/factory programmable for 6, 9, 12, 18, 24, 36, and 40 cell Eclipse IIs. This feature reduces the quantity of spare parts inventory. See Figure 8-1 for further information.

Refresh Charge Feature — A refresh charge of a storage battery is a charge given to charged and wet batteries which are in storage or inactive periods to replace losses due to local action and to insure that every cell is brought periodically to a full state of charge. The EC2000 Control has an adjust-

This page intentionally left blank.

EC2000 CONTROL FEATURES

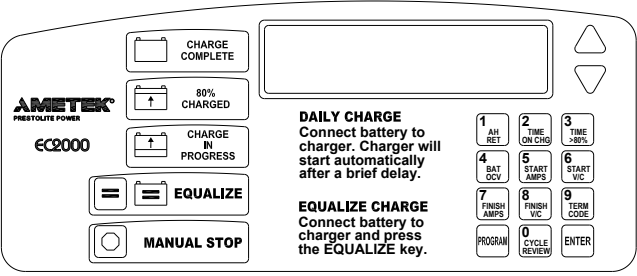

Figure 7-1

Main Features

1. Multi-Voltage Charging Capability
2. Multi-Ampere-Hour Charging Capability
3. Automatic or Manual Battery Temperature Compensation
4. 15 Minute Minimum DV/DT Charge Termination
5. 2x20 Character Alphanumeric Display
6. Four LEDs for Status Display
7. LED lamp test provided on start up
8. Manual Stop Capability
9. One touch Review of Charge Cycle Information during charge cycle or after charge complete
 - Amp hours returned during charge cycle
 - Total time on charge
 - 80% point to end of charge timer
 - Battery open circuit voltage
 - Start current
 - Start voltage (volts/cell)
 - Finish current
 - Finish voltage (volts/cell)
 - Charge termination code
10. Review of Charge Cycle Data and Programmed Features
11. Review of Archived Charge Cycle Data for the Last 512 Charge cycles.
 - Amp hours returned during charge cycle
 - Total time on charge
 - 80% point to end of charge timer
 - Battery open circuit voltage
 - Start current
 - Start voltage (volts/cell)
 - Finish current
 - Finish voltage (volts/cell)
 - Charge termination code
 - Equalize time
 - Start time
 - End time
 - Battery I.D.
 - Battery I.D. start temperature
 - Battery I.D. end temperature
 - Cycle ampere-hours
 - Cycle cell size
 - Battery Type
 - Month
 - Date
12. Automatic or Push-to-Start Operation
13. Manual or Automatic Equalize Operation
14. Fault Lock-out or No Fault Lock-out Operation
15. Back-up Timer Shutdowns
16. Failure Mode Diagnostics
 - High Battery Reject
 - Low Battery Reject
 - Battery Reject
 - Battery Over-temperature
 - Setup Error
 - Low Voltage S.D.
 - Charge Curve Error
 - Low Current S.D.
 - Backup Timer
 - Manual Stop
 - Fault Lockout
 - Over Maximum Amp Hour Returned S.D.
 - Charger Overtemperature S.D.
 - DIDT S.D.
 - Phase Error
17. One Part Number Control is User/Factory programmable for 6-9-12-18-24-36-40 Cells.
18. Adjustable 8-99 Hour Refresh Charge Delay
19. Voltage Time Feature (DV/DT Disable)

able 8 to 99 hour refresh charge timer (programmed through the "Refresh Delay" function) which starts with a normal charge complete, either DV/DT or voltage time. If a battery is left connected to the charger for the Programmed number of hours after a charge complete, the control will automatically begin a refresh charge cycle. The control will start automatically even if programmed for time-of-day start, delayed start or push-to-start operation. The EC2000 will not start the charge cycle during a time-of-day blockout period. It will automatically request an equalize cycle if it is programmed to equalize on that day. Charge cycle data (Functions #1-50) is not affected by a refresh charge. The charge termination technique for a refresh charge will be DV/DT regardless of how the control is user programmed, and the 0-80% back-up timer will be four hours and fifteen minutes during a refresh charge. This feature will insure that any battery left connected to the charger for extended periods of time will not be damaged due to self-discharge, and will be kept in a fully charged state.

Finish Cell Forming Feature — The EC2000 Control can be programmed to provide voltage-time charge termination and disable the low current shutdown feature for a limited number of charge cycles.

The number of cycles programmed into the Forming Cycles function will be forming cycles and that number will be decrement each time a charge complete condition is reached. The number of forming cycles selected can be from 0 to 30 charge cycles.

Input Kilowatt Hour Feature — The Control will calculate the *approximate* input kilowatt hour usage for each charge cycle. This feature may be helpful in determining the cost of charging given various charging scenarios with known electricity costs.

80% Charged Point — A standard EC2000 Control will light the "80% Charged" LED and enable the charge termination routine when the battery voltage reaches the gassing voltage and the charging has decreased below start current. The gassing voltage is nominally 2.40 volts/cell and is adjusted automatically when the charger output voltage is modified to charge batteries of different temperatures.

Data Retention — The EC2000 Control uses 2 types of electronic memory for data retention. Real time clock data is kept current by a non user replaceable lithium battery in the absence of AC power. All other program memory and charge cycle information is resident in non-volatile memory. The minimum data retention time should be at least 10 years.

WARNING: Enabling the Finish Cell Forming feature will cause the charger to continue to run for a period of time if the battery has been disconnected before Charge Complete or pressing the Manual Stop key. This condition will continue until the programmed number of cycles have been completed. The battery should never be disconnected while a charge is in progress.

Time-of-Day Start — The EC2000 Control can be programmed to delay the start of a charge cycle until a specific time of day. Any time of day, in one minute increments, can be used for the time-of-day start time.

When a EC2000 is programmed for time-of-day start, and a battery is connected to the charger, the programmed start time will be displayed. This feature can be used to save on energy costs, provide a battery cool down period, or to prevent opportunity charging.

Delayed Start — The EC2000 Control can be programmed to delay the start of a charge cycle for a specific period of time. Any time period from 1 minute to 23 hours and 59 minutes, in one minute increments, can be used for the delayed start period.

When a EC2000 is programmed for delayed start, and a battery is connected to the charger, the programmed delay time will be displayed.

The time displayed will be decremented once per minute so that the time displayed is always the amount of time remaining before the start of charge. This feature can be used to save on energy costs, provide a battery cool down period, or to prevent opportunity charging.

Time-of-Day Blockout — The EC2000 Control can be programmed to disable the charger during a specific time of day. The charger will turn off at the beginning of the block-out period, and resume the charge cycle at the end of the block-out period. Any period of time of day, in one minute increments, can be used for the time-of-day block-out period. When a EC2000 is programmed for time-of-day block-out, and a battery is being charged when the block-out period occurs, the programmed end of block-out time will be displayed. This feature can be used to save on energy costs, provide a battery cool down period, or to prevent opportunity charging.

Manual Override of Programmed Start Modes — A EC2000 Control, when programmed for time-of-

day start, delayed start, or time-of-day block-out, can be manually overridden by pressing the “Enter” pushbutton while the start of the charge cycle is being automatically delayed by the control. This manual override feature can be disabled through the “Start Override” programming function. The manual override feature allows the operator to start a charge cycle immediately if a battery is needed sooner than the programmed start time would allow.

Automatic Equalize — The EC2000 Control can be programmed for 3 different types of automatic equalize. EC2000 Controls are shipped from the factory programmed to automatically provide an equalize charge to every fifth complete charger cycle. The number of cycles between equalize requests can be varied from 0 to 30. If the EC2000 is programmed to automatically provide an equalize cycle every zero cycles, then an equalize charge cannot be requested manually and will never be provided automatically. The second type of automatic equalize mode is when an equalize charge is desired on a particular day of the week. When programmed for automatic equalize by day of week, the EC2000 will provide an equalize charge to any battery which is connected to the charger on the programmed equalize day. Additionally, any battery which is connected the charger previous to the day of week equalize day will be given an equalize charge provided that it is at a charge complete status when the EC2000’s clock calendar switches to the equalize day. The automatic equalize features allow for the consistent application of equalize charges without constant attention by the operators. The third type of equalize is by BID count. When programmed for this mode, the current complete cycle count is read from the BID at connect and compared to that of the equalize cycle counter. An equalize will be requested when the BID count equals the equalize cycle count programmed into function 22.

For further information on programming and reviewing the EC2000 features, refer to the Programming Your EC2000 chapter and the Reviewing EC2000 Charge Data section of this chapter.

Programmable Cool Down Time — A programmable cool down feature allows the battery to cool down for 0 to 8 hours before the charger signals charge complete. During the cool down period the alphanumeric display reads “Cool Down”. This feature allows the battery to cool down before being returned to use and can be used to minimize the battery maximum temperature during operation.

Start Gassing – A programmable time that effects how long from the start of a charge cycle before the gassing portion can begin. If the battery on charge reaches the finish portion of the curve and the gassing time has not elapsed, the charger will shutoff and display “No Gassing”. This minimizes any bat-

tery gassing that may occur during an opportunity charge cycle. Once the start gassing time is past, the charger will restart at the standard finish current and complete the charge cycle. This feature only works when the charger is in Opportunity Charging mode.

Maximum Battery Temperature — The EC2000 Control can be programmed to interrupt the charge cycle if the battery temperature exceeds the limit programmed into function. The temperature may be programmed from 80°F to 150°F. Once the battery cools down past the trip temperature the charge cycle will be resumed. The display will show “Battery Cooling” if the charge has been interrupted and the cooling period is taking place. A BID must be in use to utilize this function.

User Programmable Password — You may enter a custom 4 number password for use in keeping programming functions protected. When the feature is enabled (function 55), you will be prompted to enter the password. After that, anytime the user tries to access the programming menu, they will be prompted for this password.

EC2000 Charge Archive Function

The archive function allows up to 20 items of charge cycle information to be retrieved and displayed. The last 512 charge cycles are stored, with the most recent cycle labeled #1 and earlier cycles labeled in ascending order.

The most recent charger cycle data is moved to the #1 archive location when the next battery to be charged is connected to the charger. At this time the all previous archive cycle data is shifted to the next highest archive location (1 to 2, 2 to 3, etc.).

The following key sequence is used to access charge cycle archive data:

Keys	Display
PROGRAM/REVIEW PROG	Enter 1-REV 2- Function 3-MAH 4-ARCH
4	Enter Arch Func # 001 01-512/00 to Download

Key in the charge cycle number and press enter.

The charge cycle data will automatically scroll through the display along with the charge cycle number. The 20 archive data items are described in detail below (see Figure 7-2).

AMP HOURS RET

The total ampere-hours returned during the charge cycle. This number includes ampere-hours delivered to the battery during the Verify, 0-80%, 80% to End, and Equalize portions of the charge cycle.

CHARGE TIME

The total charging time of the charge cycle. This number includes the time of the Verify, 0-80% 80% to End, and Equalize portions of the charge cycle.

80% TO END

The time the battery was charged from the 80% charged point until DV/DT or VT (depending on the control setting) charge termination. This time does not include any equalize charging time that may have been automatically or manually selected.

BATTERY OCV

The open circuit voltage of the battery immediately before the beginning of the charge cycle.

START AMPS →

The value of the current delivered to the battery at the start of the charge cycle.

START VOLTS

The value of the battery voltage (in volts/cell) of the battery at the start of the charge cycle.

FINISH AMPS

The value of the charge current delivered to the battery at the end of the charge cycle.

FINISH VOLTS

The value of the battery voltage at the end of the charge cycle.

TERM

The reason for charge cycle termination. All possible codes are listed below:

1-Charge Comp	Normal Charge Complete
2-Low Current	Low Current Error shutdown
3-Manual Stop	Manual stop
4-Battery Dis	Battery disconnected while charging
5-<80 Backup	0-80% Back-up Timer Error Shutdown.
9-Curve Error	Charger Output Curve Error Shutdown
10-Overtemperature	Excessive Charge Component Heating
11-Phase Error	Unbalanced Input Line Error Shutdown
12-Didt	Rising Current/Falling Voltage Error shutdown
13-Lvsd	Low Charging Voltage Error Shutdown
14-Ahsd	Excessive AH Returned Error Shutdown

16-Arcless

The Arcless circuit is open

EQUALIZE TIME

The time of the equalize portion of the charge cycle. Equalize can be automatically or manually selected.

START TIME

The time at the start of the charge cycle (military format).

END TIME

The time at the end of the charge cycle. Includes the equalize time if it was automatically or manually selected (am/pm format).

BATTERY I.D.

The Battery I.D. number of the battery that was charged in the charge cycle. Requires Prestolite Battery Identification Module (BID).

BID START TEMP

The temperature of the battery sensed by the Prestolite Battery Identification Module at the start of the charge cycle.

BID END TEMP

The temperature of the battery sensed by the Prestolite Battery Identification Module at the end of the charge cycle.

CYC. AMP HOURS

The Ampere-hour setting of the charger during the charge cycle. This value cannot exceed the maximum charger output rating.

CYCLE CELLS

The Cell Size setting of the charger during the charge cycle. This value cannot exceed the maximum charger output rating.

BATTERY TYPE

The Battery Type setting of the charger during the charge cycle. This value cannot exceed the maximum charger output rating.

PRESENT MONTH

The month that the charge cycle occurred.

PRESENT DATE

The day of the month that the charge cycle occurred.

EC2000 Charge Cycle Review Function

The review function allows up to 66 items of charge cycle information to be retrieved and displayed. Only the last charge cycle is stored, with the data being moved into archive cycle #1 location when the next battery is connected to the charger. The review data functions described in detail below in ascending order.

A single review item can be accessed by entering its item number at the "Enter Rev Func # " prompt.

The following key sequence is used to access charge

cycle review data functions.

Keys	Display
Program/Review	Enter 1-REV 2-PROG Function 3-MAH 4-ARCH
1	Enter Rev Func # 01

Key in function number and press enter or scroll using arrow keys to review entire charge cycle (see Fig. 7-2). You may re-enter a new function number at any time to jump through the menu quickly.

01. AMP HOURS RET

The total ampere-hours returned during the charge cycle. This number includes ampere-hours delivered to the battery during the Verify, 0-80%, 80% to End, and Equalize portions of the charge cycle.

02. CHARGE TIME

The total charging time of the charge cycle. This number includes the time of the Verify, 0-80%, 80% to End, and Equalize portions of the charge cycle.

03. 80% TO END

The time the battery was charged from the 80% charged point until DV/DT or VT (depending on the control setting) charge termination. This time does not include any Equalize charging time that may have been automatically or manually selected.

04. BATTERY OCV

The open circuit voltage of the battery immediately before the beginning of the charge cycle.

05. START AMPS

The value of the current delivered to the battery at the start of the charge cycle.

06. START VOLTS

The value of the battery voltage (in volts/cell) of the battery at the start of the charge cycle.

07. FINISH AMPS

The value of the charge current delivered to the battery at the end of the charge cycle.

08. FINISH VOLTS

The value of the battery voltage at the end of the charge cycle.

09. TERM

The reason for charge cycle termination. All possible codes are listed below:

1-Charge Comp	Normal Charge Complete
2-Low Current	Low Current Error shutdown
3-Manual Stop	Manual stop
4-Battery Dis	Battery disconnected while charging
5-<80 Backup	0-80% Back-up Timer Error Shutdown.

9-Curve Error	Charger Output Curve Error Shutdown
10-Overtemperature	Excessive Charge Component Heating
11-Phase Error	Unbalanced Input Line Error Shutdown
12-Didt	Rising Current/Falling Voltage Error shutdown
13-Lvsd	Low Charging Voltage Error Shutdown
14-Ahsd	Excessive AH Returned Error Shutdown
16-Arcless	The Arcless circuit is open

10. EQUALIZE TIME

The time of the equalize portion of the charge cycle. Equalize can be automatically or manually selected.

11. START TIME

The time at the start of the charge cycle (AM/PM format).

12. END TIME

The time at the end of the charge cycle. Includes the equalize time if it was automatically or manually selected (Military format).

13. CHARGER HEAT SINK TEMPERATURE

The last recorded temperature of the charger power components heat sink while the charger was charging.

14. BATTERY I.D.

The Battery I.D. number of the battery that was charged in the charge cycle. Requires Prestolite Battery Identification Module (BID).

15. BATTERY VOLTS

The present voltage of the battery connected to the battery charger (volts DC).

16. CYCLE Kwh

The estimated Kilowatt Hour usage for the last charge cycle.

17. BID START TEMP

The temperature of the battery sensed by the Prestolite Battery Identification Module at the start of the charge cycle (degrees F).

18. BID END TEMP.

The temperature of the battery sensed by the Prestolite Battery Identification Module at the end of the charge cycle (degrees F).

19. PRESENT TIME

The present time (AM/PM format).

20. WEEK DAY

The present day of week (SUN through SAT).

21. EQUALIZE TYPE

The type of auto equalize selected. The types that can

be selected are listed below:

CYC. = By cycle count (see AUTO EQ. COUNT).

D.O.W. = By the day of week (see Auto EQ. Day).

BID = By BID count

22. EQUALIZE CYCLES

The number of charge cycles between equalize charges when the auto equalize function is programmed "ON" and the auto equalize type is set to "COUNT".

23. EQ. DAY

The day of the week that an equalize charge cycle is performed when the auto equalize function is "ON" and the auto equalize type is set to "DAY".

24. AUTO EQUALIZE

Shows the auto equalize function on or off.

Auto equalize "OFF"
Auto equalize "ON"

25. T.O.D. START

Time of day start time. (AM/PM). See START MODE.

26. DELAYED START

Delayed start time interval. (00H 00M to 23H 59M). See START MODE.

27. BLOCK START

The beginning time of the time of day blockout function (AM/PM). See START MODE

28. BLOCK END

The ending time of the time of day blockout function. (AM/PM). See START MODE.

29. START OVERRIDE

The start override function that allows the operator to override any of charger start modes (i.e. delayed start, time of day start, or time of day blockout) by pressing the ENTER key.

30. START MODE

Shows the selected start mode for the start of the charge cycle.

AUTO = Automatic mode
T.O.D.S. = Time of day start mode
DELAYED = Delay start mode
T.O.D.B. = Time of day blockout
TIMER = Timer Mode

31. FORMING CYCLES

The number of forming cycles for a new battery by disabling the low current shutdown, and setting VT Termination mode for the programmed number of cycles (00 to 30).

32. SPECIAL OPTION

Special option modes see below.

OFF

"P.T.S." = Push to start mode.

The charger will not start until the "ENTER" key is pressed.

F.L.O. = Fault lockout mode.

The charger will not restart until any faults are reset by pressing the "ENTER" key with no battery connected.

33. CYC. AMP HOURS

The ampere-hour setting of the charger during the charge cycle. This value cannot exceed the maximum charger output rating.

34. CYCLE CELLS

The cell size setting of the charger during the charge cycle. This value cannot exceed the maximum charger output rating.

35. FIXED CELL SIZE

The cell size the charger will operate at if the "multi-cell mode" is not selected and the charger does not detect a Prestolite BID module. See "MULTI-CELL MODE".

36. FIXED AMP HRS

The ampere-hour size the charger will operate at if the charger does not detect a Prestolite BID module.

37. FIX.BAT.TEMP.

The battery temperature used for charger output voltage compensation, if the charger does not detect a Prestolite BID Module (032 to 132°F).

CAUTION: Do Not Exceed the Battery Manufacturer's Maximum allowed Battery temperature.

38. BATTERY TYPE

The battery type the charger uses to select the proper output voltage and current characteristic, if the charger does not detect a Prestolite BID.

FLD = Standard flooded lead acid industrial type battery curve.

CTM. = Custom curve. Uses the voltage and current values programmed in the STRT A/100 A.H., FIN. A/100A.H., GAS. V/C., and LID. V/C.

YGR
SLR
DSG = Sealed lead acid battery curves
SLE
DAG
CDR

*MAH will be displayed if the Multi-Amp Hour Feature is turned on.

39. START AMPS/100

The selected output curve start current setting (10.0 to 16.3 amps per 100 ampere-hours).

40. FINISH AMPS/100

The selected output curve finish current setting (0.0 to 7.9 amps per 100 ampere-hours).

41. GASSING V/C

The selected output curve gassing voltage level setting (2.00 to 2.99 volts/cell).

42. LID. V/C

WARNING: Enabling the Finish Cell Forming feature will cause the charger to continue to run for a period of time if the battery has been disconnected before Charge Complete or pressing the Manual Stop key. This condition will continue until the programmed number of cycles have been completed. The battery should never be disconnected while a charge is in progress.

The selected output curve lid voltage setting (2.00 to 2.99 volts/cell).

43. CHARGER I.D.

The battery charger identification number.

Factory setting = 0000

44. REFRESH DELAY

The number of hours before the charger automatically starts and refresh charges a battery that has not been disconnected (8 to 99 hours).

Factory Setting = 72 hours.

45. DVDT DISABLE

Disables the automatic DV/DT charge termination feature and enables Voltage Time charge termination.

OFF = (DV/DT Mode)

ON = (VT mode)

46. PRESENT MONTH

The current month (1 to 12)

47. PRESENT DATE

The current day of the month (1 to 31).

48. PRESENT YEAR

The current year (00 to 99).

49. MULTICELL MODE

Enables the automatic cell selection mode of operation for the charger. When turned off, charger operates at the Fixed cell size (see FIX. CELL SIZE).

50. COOL DOWN HOURS

The number of hours cool down from the end of charge until charge complete is indicated by the charger (0 to 8).

51. BID CELLS

If a connected battery is equipped with a Battery I.D. module, the battery cells size (6,9,12,18,24,36) may be reprogrammed into the BID. The control must be in "Manual Stop" status.

52. BID NUMBER

If a connected battery is equipped with a Battery I.D. module, the I.D. number (001-999) may be reprogrammed into the BID. The control must be in "Manual Stop" status.

53. BID AMP HOURS

If a connected battery is equipped with a Battery I.D. module, the battery amp-hour size (0000-9999) may be reprogrammed into the BID. The control must be in "Manual Stop" status.

54. BID BATTERY TYPE

If a connected battery is equipped with a Battery I.D. module, the battery type may be programmed into the BID. The control must be in "Manual Stop" status.

- 00 FLD Flooded Lead Acid
- 01 CTM Custom curve (programmable)
- 02 YGR Sealed battery curve
- 03 SLR Sealed battery curve
- 04 DSG Sealed battery curve
- 05 SLE Sealed battery curve
- 06 DAG Sealed battery curve
- 07 CDR Sealed battery curve

55. PASSWORD

Optional password required to program if turned on.

56. NO GASSING HOURS

The number of Hours before the charger can begin the gassing portion of the charging cycle. (0 – 8 Hours)

57. MAX BATT TEMP

The maximum battery temperature for charging to start or continue. Once interrupted, the charge will restart after the temperature drops 5 degrees F below the trip point. (For use with BID only)

58. BID START AMPS

Programs the charger start rate at the programmed BID AH rating to the selected amps/100AH. For example, to charge an 800AH battery at 320 amps, the “BID Start Amps” would be programmed to 40A/100AH. Please note that if the programmed rate exceeds the maximum rated charger amps, the charger output will be limited to the maximum current rating. **Not Available on the Standard Eclipse II Charger.**

59. BATTERY CHARGE AMP HOURS

The accumulated amp hours charged into the battery. An Amp Hour Accumulator and BID module assembly must be installed on the battery to use this function. The Amp Hour Accumulator continually records this data while it is installed on the battery.

The data is automatically read from the bid when the control terminates each charge cycle, except for Manual Stop. The data is stamped with the date and BID number.

60. BATTERY DISCHARGE AMP HOURS

The accumulated amp hours discharged from the battery. An Amp Hour Accumulator and BID module assembly must be installed on the battery to use this function. The Amp Hour Accumulator / BID continually records this data while it is installed on the battery.

The data is automatically read from the bid when the control terminates each charge cycle, except for Manual Stop. The data is stamped with the date and BID number.

61. LONG TERM AVERAGE BATTERY TEMPERATURE

The average BID temperature of the battery. An Amp Hour Accumulator and BID module assembly must be installed on the battery to use this function. The BID continually updates the average while it is installed on the battery.

The data is automatically read from the bid when the control terminates each charge cycle, except for Manual Stop. The data is stamped with the date and BID number.

62. BATTERY CYCLES

The number of battery discharge cycles, based on the total discharge amp hours and 80% of the BID amp hour setting. An Amp Hour Accumulator and BID module assembly must be installed on the battery to use this function. The control continually updates this calculation using the total accumulated discharge amp hours read in from the BID.

63. CHARGE/DISCHARGE RATIO

The ratio of the total charge amp hours over the total discharge amp hours. An Amp Hour Accumulator and BID module assembly must be installed on the battery to use this function. The control continually updates this calculation using the total accumulated charge and discharge amp hours read in from the BID.

64. LCD DISPLAY CONTRAST ADJUST

Make this adjustment if the LCD display is difficult to read. Be sure the unit is in its permanent mounted position before making the adjustment.

For example, to charge an 800AH battery at 320 amps, the "battery start amps" would be programmed to 40A/100AH. *Please note that if the programmed rate exceeds the maximum rated charger amps, the charger output will be limited to the maximum current rating.* **Not Available on the Standard Eclipse II Charger**

65. MAX CELL SIZE

Programs the Max Cell Size available on 40 cell Chargers in the multi-cell mode. The charger cannot automatically recognize the difference between 40 and 36 cell sizes and therefore, the Max Cell Size in that mode must be programmed to 36 or 40 cells. Regardless of this setting, 36 or 40 cell batteries with properly programmed Prestolite BID modules will correctly be charged.

36 = 36 Cells

40 = 40 Cells

65. FIXED START AMPS

Programs the charger start rate at the programmed charger AH setting to the selected amps/100AH.

EC2000 ARCHIVE, REVIEW & PROGRAMMING MENU STRUCTURE

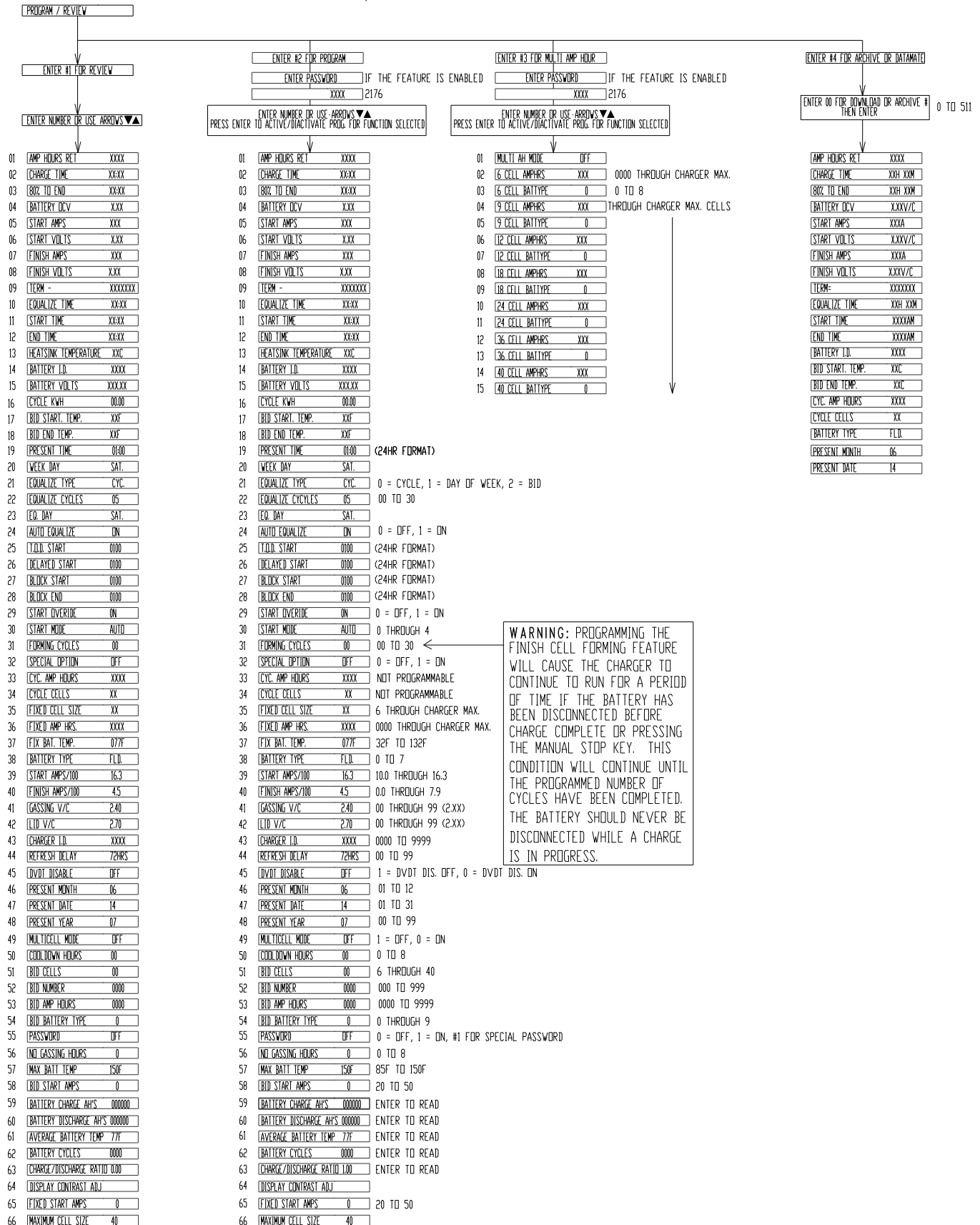

WARNING: PROGRAMMING THE FINISH CELL FORMING FEATURE WILL CAUSE THE CHARGER TO CONTINUE TO RUN FOR A PERIOD OF TIME IF THE BATTERY HAS BEEN DISCONNECTED BEFORE CHARGE COMPLETE OR PRESSING THE MANUAL STOP KEY. THIS CONDITION WILL CONTINUE UNTIL THE PROGRAMMED NUMBER OF CYCLES HAVE BEEN COMPLETED. THE BATTERY SHOULD NEVER BE DISCONNECTED WHILE A CHARGE IS IN PROGRESS.

Figure 7-2

Programming Your EC2000 Control

The programming function allows 42 functions to be programmed to customize your Prestolite Eclipse II to your battery charging application. Programming is not available during an active charge cycle, and can only be accessed before battery connect or after charge termination.

All programmable functions are keyed with the sequence shown below. To prevent unauthorized access, use the optional password feature. Any single programming item can be accessed by entering its function number at the prompt or by using the arrow keys to scroll to the item. If the password feature is used and the improper number is entered, the control will reject access to programming and display "Password Failed". The sequence may then be started over.

Keys Display

Program/Review	Enter	1-REV	2-PROG
	Function	3-MAH	4-ARCH
2	Enter	Prog	Func #

Enter password if required. Key in function number or scroll using arrow keys to reach the desired programming function (see Figure 7-2).

Once the desired function is reached, press the "enter" key to enable programming. Functions 33/34 and 59-63 are not programmable. On functions with several numeric data fields, the display will show "Enter Numeric Value". The flashing digit will change as the entries are keyed in. Press the "Enter" key again when programming of that function is complete. On functions with 1 or 2 data places, the display will show " to Change Data". Use the arrow keys to increment or decrement the data. Again press the "Enter" key when programming of that function is complete.

19. PRESENT TIME

The current time. Program in 24 hour military time format (0000 to 2359 military time).

20. WEEK DAY

The present day of week (SUN through SAT).

1 = Sunday

Use the up or down arrow to select the proper setting.

21. EQUALIZE TYPE

The type of auto equalize selected. The types that can be selected are listed below.

By cycle count (see AUTO EQ. COUNT).
Factory setting.

By the day of week (see AUTO EQ. DAY).

By BID cycle count

Use the up or down arrow to select the proper setting.

22. EQUALIZE COUNT

The number of complete charge cycles between equalize charges when the auto equalize function is programmed "ON" and the auto equalize type is set to "COUNT" or "BID".

05 = factory setting

Use the up or down arrow to select the proper setting.

23. EQ. DAY

The day of the week that an equalize charge cycle is performed when the auto equalize function is "ON" and the auto equalize type is set to "DAY".

Saturday = factory setting

Use the up or down arrow to select the proper setting.

24. AUTO EQUALIZE

Sets the auto equalize function on or off.

Auto equalize "ON" = Factory Setting

Use the up or down arrow to select the proper setting.

25. T.O.D. START

Sets the time of day start time (0000 to 2359 military time). See START MODE.

Factory = 01:00

26. DELAYED START

Sets the delayed start time interval (00H 00M to 23H 59M)

Factory = 00H 00M. See START MODE

27. BLOCK START

Sets the beginning time of the time of day blackout function (0000 to 2359 military time). See START MODE.

Factory = 01:00

28. BLOCK END

Sets the ending time of the time of day blackout function (0000 to 2359 military time). See START MODE.

Factory = 01:00

29. START OVERRIDE

Sets the start override function that allows the operator to override any of the charger start modes (i.e.; delayed start, time of day start, or time of day blackout).

On = Factory setting

Use the up or down arrow to select the proper setting.

30. START MODE

Selects the desired start mode for the start of the charge cycle.

Automatic mode	"AUTO" factory setting
Time of day start mode	"T.O.D.S."
Delay start mode	"DEL.S."
Time of day blackout	"T.O.D.B."
Timer	TIMER MODE

Use the up or down arrow to select the proper setting.

31. FORMING CYCLES

Sets the number of forming cycles for a new battery by disabling the low current shutdown and setting VT Termination mode for the programmed number of cycles (00 to 30).

00 = Factory Setting

Use the up or down arrow to select the proper setting.

WARNING: Enabling the Finish Cell Forming feature will cause the charger to continue to run for a period of time if the battery has been disconnected before Charge Complete or pressing the Manual Stop key. This condition will Continue until the programmed number of cycles have been completed. The battery should never be disconnected while a charge is in progress.

32. SPECIAL OPTION

Sets special option modes, see below:

OFF = factory setting
"P.T.S." Push to start mode

The charger will not start until the "ENTER" key is pressed.

"F.L.O." Fault lockout mode

The charger will not restart until any faults are reset

by pressing the "ENTER" key and no battery is connected.

Use the up or down arrow to select the proper setting.

33. CYC. AMP HOURS

The ampere-hour setting of the charger during the last charge cycle. This value cannot exceed the maximum charger output rating. **Not programmable.**

34. CYCLE CELLS

The cell size setting of the charger during the last charge cycle. This value cannot exceed the maximum charger output rating. **Not programmable.**

35. FIXED CELL SIZE

The cell size the charger will operate at if the "multi-cell mode" is not selected and the charger does not detect a Prestolite BID module. See "MULTI-CELL MODE".

Factory setting = nameplate rating

06 = 6 cells	
09 = 9 cells	
12 = 12 cells	
18 = 18 cells	
24 = 24 cells	
36 = 36 cells	only available on
40 = 40 cells	36 & 40 cell units

NOTE: Maximum setting is the charger Nameplate rating.

36. FIXED AMP HRS.

The ampere-hour size the charger will operate at if The charger does not detect a Prestolite BID module (0001 to nameplate rating).

Factory Setting = nameplate rating

NOTE: Maximum setting } is the charger Nameplate rating.

37. FIX. BAT. TEMP.

The battery temperature used for charger output voltage compensation, if the charger does not detect a Prestolite BID module (032 to 132°F).

77° = Factory Setting

CAUTION: Do Not Exceed the Battery Manufacturer's Maximum allowed Battery temperature.

38. BATTERY TYPE

The battery type the charger uses to select the proper output voltage and current characteristic, if the charger does not detect a Prestolite BID.

- 0 = FLD Standard flooded lead acid industrial type battery curve. Factory setting
- 1 = CTM. Custom Curve. Uses the voltage and current values programmed in the STRT. A/100A.H., FIN. A/100A.H., GAS. V/C, and LID. V/C.
- 2 = S.L.A. Sealed Lead Acid battery curve
- 3 = S.L.R. A charge curve that meets the requirements of some AGM (Absorbed Glass Mat) Type Lead Acid Batteries
- 4 = D.S.G. Sealed Lead Acid battery charge curve that meets requirements of the EPM "DEKA" Sealed Lead Acid battery.
- 5 = S.L.E. Sealed Lead Acid battery curve
- 6 = D.A.G. Sealed Lead Acid battery curve
- 7 = C.D.R. Sealed Lead Acid battery curve

Use the up or down arrow to select the proper setting.

NOTE: Functions 39 through 42 apply only to the custom curve and cannot be changed unless the custom curve has been selected in Function 38.

39. START AMPS/100

The custom output curve start current setting (10.0 to 16.3 amps per 100 ampere-hours).

Factory setting = 16.3

40. FINISH AMPS/100

The custom output curve finish current setting (0.0 to 7.9 amps per 100 ampere-hours).

Factory Setting = 5.0

NOTE: For Functions 41 and 42, only information to the right of the decimal point can be entered.

41. GASSING V/C.

The custom output curve gassing voltage level setting (2.00 to 2.99 volts/cell).

Factory setting = 2.40

42. LID. V/C.

The custom output curve lid voltage setting (2.00 to 2.99 volts/cell).

Factory setting = 2.70

43. CHARGER I.D.

The battery charger identification number.

Factory setting = 0000

44. REFRESH DELAY

The number of hours before the charger automatically starts and refresh charges a battery that has not been disconnected (8 to 99 hours).

Factory setting = 72 hours.

45. DVDT DISABLE

Disables the automatic DV/DT charge termination

feature and enables Voltage Time charge termination.

- OFF (DV/DT mode) factory setting
- ON (VT mode)

Use the up or down arrow to select the proper setting.

46. PRESENT MONTH

The current month (1 to 12).

47. PRESENT DATE

The current day of the month (1 to 31).

48. PRESENT YEAR

The current year (00 to 99).

49. MULTICELL MODE

Enables the automatic cell selection mode of operation for the charger. When turned off the charger operates at the Fixed Cell Size (see FIXED CELL SIZE).

- OFF
- ON Factory Setting

Use the up or down arrow to select the proper setting.

50. COOL DOWN HOURS

The number of hours cool down from the end of charge until charge complete is indicated by the charger (0 to 8).

- 0 = factory setting.

Use the up or down arrow to select the proper setting.

BID Programming

The following conditions must be met before a Prestolite BID can be programmed or reprogrammed with this charger.

- a. A battery with the correct cell size BID must be connected to the charger.
- b. The charger must be in the Manual Stop condition
- c. The control must be set to the programming menu and functions 51 thru 54 must be selected.

After the above conditions are met the BID can be properly programmed.

After a number entry is keyed in, the control will immediately attempt to program it in the BID while displaying "WRITING BID". If the entered number is out of range or is not accepted by the BID, the control will return to the original prompt with all 0's displayed for the entered data. If the BID properly

accepts the data, the programmed number will be returned to the display.

51. BID CELLS

Programs the Cell Size into the BID. Once programmed the charger will recognize the battery upon connection, bypass the battery cell size verify function, and charge to the programmed BID cell size.

- 06 = 6 Cells
- 09 = 9 Cells
- 12 = 12 Cells
- 18 = 18 Cells
- 24 = 24 Cells
- 36 = 36 Cells
- 40 = 40 Cells

52. BID NUMBER

Programs the battery identification number into the BID. (000 to 999)

53. BID AMP HOURS

Programs the battery ampere hour rating into the BID. Once programmed the charger will recognize the battery upon connection and charge the battery at the proper charge rates or the max charger output, whichever is greater. (0000 to 9999)

54. BID BATTERY TYPE

Programs the battery type into the BID. Once programmed, the charger will recognize the battery type upon connection, and charge the battery with the proper curve.

- 0 = Flooded Curve
- 1 = Custom Curve
- 2 = Sealed Lead Acid Curve
- 3 = Sealed Lead Recombinant Curve Absorbed Glass Mat (AGM) Types
- 4 = Sealed Lead Acid Curve ("DEKA" and Other Gel Types)
- 5 = Sealed Lead Acid Curve
- 6 = Sealed Lead Acid Curve
- 7 = Sealed Lead Acid Curve

55. PASSWORD

- OFF = Factory Setting
- On = Password Enabled

Use the up or down arrow to select the proper setting.

56. NO GASSING HOURS

The number of Hours before the charger can begin

the gassing portion of the charging cycle. (0 – 8 hours)

Factory setting = 00 hours

Use the up or down arrow to select the proper setting.

57. MAX BATT TEMP

The maximum battery temperature for charging to proceed. (For use with BID only)
(080 to 150 degrees F)

Factory setting = 150

58. BID START AMPS

Programs the charger start rate at the programmed BID AH rating to the selected amps/100AH. For example, to charge an 800AH battery at 320 amps, the "BID Start Amps" would be programmed to 40A/100AH. *Please note that if the programmed rate exceeds the maximum rated charger amps, the charger output will be limited to the maximum current rating*

Not Available on the Standard Eclipse II Charger

59. BATTERY CHARGE AMP HOURS

The accumulated amp hours charged into the battery. An Amp Hour Accumulator and BID module assembly must be installed on the battery to use this function. The Amp Hour Accumulator continually records this data while it is installed on the battery.

The data is automatically read from the bid when the control terminates each charge cycle, except for Manual Stop. The data is stamped with the date and BID number.

Read the data "on demand" by pressing the "Stop" key. *

Press and hold the "Equalize" button for 10 seconds to reset all data. *

60. BATTERY DISCHARGE AMP HOURS

The accumulated amp hours discharged from the battery. An Amp Hour Accumulator and BID module assembly must be installed on the battery to use this function. The Amp Hour Accumulator / BID continually records this data while it is installed on the battery.

The data is automatically read from the bid when the control terminates each charge cycle, except for Manual Stop. The data is stamped with the date and BID number.

Read the data “on demand” by pressing the “Stop” key. *

Press and hold the “Equalize” button for 10 seconds to reset all data. *

61. LONG TERM AVERAGE BATTERY TEMPERATURE

The average BID temperature of the battery. An Amp Hour Accumulator and BID module assembly must be installed on the battery to use this function. The BID continually updates the average while it is installed on the battery.

The data is automatically read from the bid when the Control terminates each charge cycle, except for Manual Stop. The data is stamped with the date and BID number.

Read the data “on demand” by pressing the “Stop” key. *

Press and hold the “Equalize” button for 10 seconds to reset all data. *

***The control must be in Manual Stop mode. Note that all data is read in, Charge AH, discharge AH and average temperature when reading in the “on demand” mode.**

62. BATTERY CYCLES

The number of battery discharge cycles, based on the total discharge amp hours and 80% of the BID amp hour setting. An Amp Hour Accumulator and BID module assembly must be installed on the battery to use this function. The Control continually updates this calculation using the total accumulated discharge amp hours read in from the BID. **NOT PROGRAMMABLE**

63. CHARGE/DISCHARGE RATIO

The ratio of the total charge amp hours over the total discharge amp hours. An Amp Hour Accumulator and BID module assembly must be installed on the battery to use this function. The control continually updates this calculation using the total accumulated charge and discharge amp hours read in from the BID. **NOT PROGRAMMABLE**

64. Display Contrast Adjust

When mounted in its permanent position the charger display should be clear and visible as possible. If it is not, try adjusting the display contrast with this function. Using the “Enter” key to get into programming mode, use the up and down arrows to make the contrast adjustment. Depending on conditions, it may take 20 or more presses of the either arrow key to make a visible change.

65. FIXED START AMPS

Programs the charger start rate at the programmed charger AH setting to the selected amps/100AH. For example, to charge an 800AH battery at 320

amps, the “battery start amps” would be programmed to 40A/100AH. *Please note that if the programmed rate exceeds the maximum rated charger amps, the charger output will be limited to the maximum current rating.*

Factory Setting = 25

Not Available on the Standard Eclipse II Charger

66. MAX CELL SIZE

Programs the Max Cell Size available on 40 cell chargers in the multi-cell mode. The charger cannot automatically recognize the difference between 40 and 36 cell sizes and therefore the Max Cell Size in that mode must be programmed to 36 or 40 cells. Regardless of this setting 36 or 40 cell batteries with properly programmed Prestolite BID modules will correctly be charged.

36 = 36 Cells
40 = 40 Cells

Use the up or down arrow to select the proper setting.

Multi AmpHour Programming Your EC2000 Control

The Multi AH Feature of the EC2000 Control allows the user to customize his Eclipse II to fit his multi-battery application. Using this feature, the flexibility of the Eclipse II can be used to charge batteries of different Amp Hour capacities and types without using Battery Identification Modules (BIDs) or different chargers with different plug types.

The control can be programmed to charge different voltage batteries with the AH rates and curve types that have been programmed for that battery voltage. When a battery is connected, the control automatically senses the battery voltage and sets the charge curve and charging rates to the level that has been programmed.

The Multi AH functions are programmed through a separate menu item on the control. Complete steps for programming a typical application are listed to the right.

Application

6 cell, 450AH Gel Type Maintenance Free
 12 cell, 680AH Flooded
 18 cell, 744AH Flooded
 800PACH3-18G Eclipse II

With the control programmed as shown to the right, the control will charge any 6 cell battery that is connected to the charger at the proper 450AH rates for a *Deka Dominator* Sealed Gel Battery. Any 12 cell battery connected to the charger will be charged at the proper 680AH rates for a standard flooded battery. Finally, any 18 cell battery connected to the charger will be charged at the proper 744AH rates for a standard flooded battery.

By enabling the Multi AH function, any 6,9,12,18,24, and/or 36 cell battery that is equal to or less than the charger rated voltage can be charged at a unique AH rate and with a unique charge curve. For example, 900PACH3-24 can be programmed to charge 6, 9,12,18 and 24 cell batteries with different AH rates and/or different charge curves.

<u>Key Entry</u>	<u>Display</u>
	Eclipse II
Program Review	Menu Tree 1 – 4
3	Multi AH Mode OFF
Enter	Multi AH Mode OFF
▲	Multi AH Mode ON
Enter	Multi AH Mode ON
▼	6 Cell Amphrs 0750
Enter	6 Cell Amphrs 0750
0450	6 Cell Amphrs 0450
Enter	6 Cell Amphrs 0450
▼	6 Cell Battype▶ FLD
Enter	6 Cell Battype▶ FLD
4	6 Cell Battype▶ DSG
Enter	6 Cell Battype▶ DSG
▼	9 Cell Amphrs 0750
▼	9 Cell Battype▶ FLD
▼	12 Cell Amphrs 0750
Enter	12 Cell Amphrs 0750
0680	12 Cell Amphrs 0680
Enter	12 Cell Amphrs 0680
▼	12 Cell Battype▶ FLD
▼	18 Cell Amphrs 0750
Enter	18 Cell Amphrs 0750
0744	18 Cell Amphrs 0744
Enter	18 Cell Amphrs 0744
▼	18 Cell Battype▶ FLD
Program Review	Menu Tree 1 – 4
Program Review	Eclipse II

Timer Start Mode Programming Your EC2000 Control

The Timer Start Mode Feature of the EC2000 Control allows the user to override the automatic start/stop features of the control and manually select the desired charge time. This can be useful for charging batteries in a maintenance shop, or for extended equalize charging of batteries with severely mismatched cells.

The Timer Start Mode can be programmed in the Program Menu at Start Mode (function #30). With the Timer Start Mode selected the charger will display CHG CYCLE TIME when a battery is connected. Charge times from 0 hours, 1 minute, to 23 hours, 59 minutes can be entered. Pressing the Enter key will start the charge. The charger will then charge the connected battery based on the any parameters that have been programmed into the control. For example, **constant current charging** can be achieved utilizing the custom curve programming in conjunction with the Timer Start Mode. Listed to the right is an example of programming an Eclipse II to constant current charge a battery for 20 hours at a 5 amp/100AH rate.

Application

24-Cell 935AH Battery
1050PACH3-24G Eclipse II

When programmed and connected as shown to the right, the charger will charge the battery at 48 amps for 20 hours before automatically shutting off.

It should be noted that any programming that is done to set up a special charge (such as Timer Start Mode, Custom Curve, etc.) must be reset to allow resumption of normal charging.

On battery connection, the control will ask for the cycle charging time to be entered. Key in 20 hours and press the "enter" key.

Key Entry	Display
	Eclipse II
Program Review	Menu Tree 1 – 4
2	Present Time 12:34
30	Start Mode Auto
Enter	Start Mode Auto
▲▲▲▲	Start Mode Timer
Enter	Start Mode Timer
36	Fixed Amp Hrs. 1050
Enter	Fixed Amp Hrs. 1050
0935	Fixed Amp Hrs. 0935
Enter	Fixed Amp Hrs. 0935
38	Battery Type FLD
Enter	Battery Type FLD
1	Battery Type CTM.
Enter	Battery Type CTM.
▼▼	Finish Amps/100 4.5
Enter	Finish Amps/100 4.5
50	Finish Amps/100 5.0
Enter	Finish Amps/100 5.0
▼	Gassing V/C 2.40
Enter	Gassing V/C 2.40
00	Gassing V/C 2.00
Enter	Gassing V/C 2.00
▼	Lid V/C 2.70
Enter	Lid V/C 2.70
99	Lid V/C 2.99
Enter	Lid V/C 2.99
Program Review	Menu Tree 1 – 4
Program Review	Eclipse II

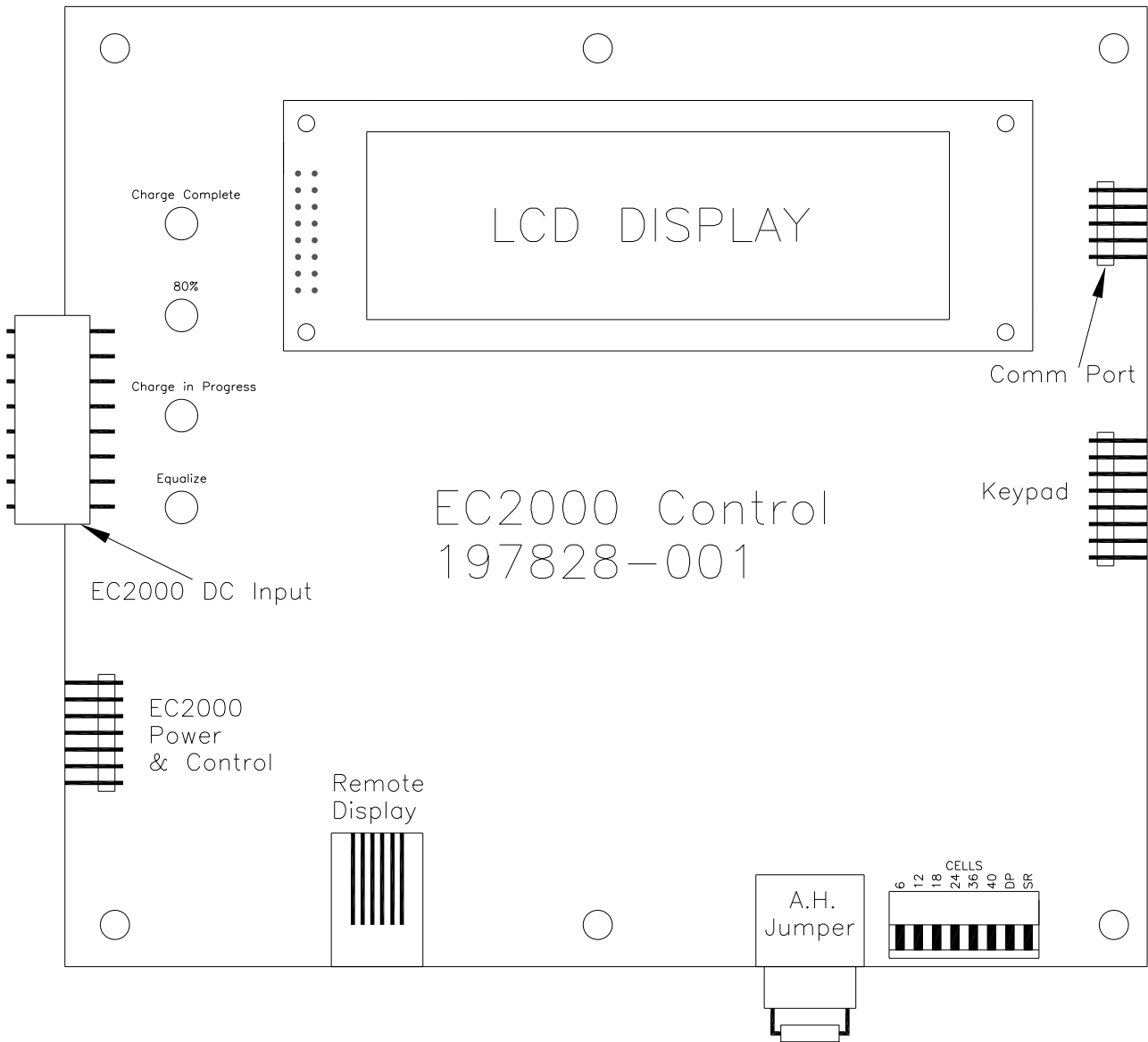

Figure 8-1

TROUBLESHOOTING

Troubleshooting Table

SYMPTOM	PROBABLE CAUSES	ACTION STEPS
No Display And No LED's	(1) No AC Voltage To Charger (2) Charger Input Fuses Are Blown (3) Bad Harness/Cable Connection (4) Bad Control Board (5) Bad Internal Charger Primary Board	1 2 3 4 5
No Keypad Response	(1) Keypad Not Connected (2) Keypad Connected Improperly (3) Bad Control Board (4) Bad Keypad	6 6 4 7
Bad LED Test	(1) Bad Control Board	4
Display Illegible/ Control Not Responding	(1) Electrically Noisy Environment (2) Low Input Voltage (3) Bad Control Board (4) Display Improperly Connected	8 9 4 10
Charger Doesn't Respond When A Battery Is Connected	(1) Output Fuse Is Bad (2) Bad Harness/Cable Connection (3) Bad Control Board (4) Output Cables Are Reversed (5) Bad Output Connector (6) Improper Battery Voltage Jumper Setting	11 3 4 12 13 14
Unit Smells Hot	(1) Inadequate Ventilation (2) Ambient Is Too Hot (3) Bad Harness/Cable Connection (4) Bad Control Board (5) Wrong Amp Hour Jumper (6) Charger Fans Not Operating (7) Bad Heat Sink Thermostat (8) Bad Internal Charger Power Board	15 16 3 4 17 18 19 5

SYMPTOM	PROBABLE CAUSES	ACTION STEPS
Battery Has Low S.G.s	<ul style="list-style-type: none"> (1) Reading Not Temperature Corrected (2) Bad Battery (3) Bad Equalize Schedule (4) Charge Curve Incorrect (5) Rates Set Incorrectly (6) Fixed Temperature Set Incorrectly (7) Too Cold (8) Bad BID (9) Not Enough Charging Time 	<ul style="list-style-type: none"> 31 32 33 25 26 27 34 28 30
Battery Doesn't Last Full Shift	<ul style="list-style-type: none"> (1) Faulty > Lift Interrupt (2) Manual Disconnect (3) A.H. Required > Battery Nameplate (4) Battery Not Providing Nameplate Rating (5) Equalize Schedule (6) Charge Curve Incorrect (7) Rates Set Incorrectly (8) Fixed Temperature Set Incorrectly (9) Bad BID (10) Charger Too Small For Battery (11) Not Enough Charging Time 	<ul style="list-style-type: none"> 20 21 22 23 24 25 26 27 28 29 30
Battery Water Usage Is Too High	<ul style="list-style-type: none"> (1) Rates Set Incorrectly (2) Fixed Temperature Set Incorrectly (3) Charge Curve Incorrect (4) Equalize Schedule (5) Control Set For Cell Forming (6) Control On Voltage/Time (7) Bad BID 	<ul style="list-style-type: none"> 26 27 25 24 35 36 28
Low Number Of A.H.s Returned To Battery	<ul style="list-style-type: none"> (1) Faulty Lift Interrupt (2) Battery Not Fully Discharged (3) Manual Disconnect (4) Rates Set Incorrectly (5) Fixed Temperature Set Incorrectly (6) Charge Curve Incorrect (7) Battery Not Providing Nameplate Rating (8) Bad Control Board (9) Bad BID (10) Charger Fans Not Operating 	<ul style="list-style-type: none"> 20 38 21 26 27 25 23 4 28 18

SYMPTOM	PROBABLE CAUSES	ACTION STEPS
Battery Temperature Too High	<ul style="list-style-type: none"> (1) Insufficient Cool Down Before And/Or After Charging (2) Battery Power Demand Too Great (3) Rates Set Incorrectly (4) Fixed Temperature Set Incorrectly (5) Charge Curve Incorrect (6) Equalize Schedule (7) Control Set For Voltage/Time (8) Control Set For Cell Forming (9) Bad BID 	<ul style="list-style-type: none"> 39 40 26 27 25 24 36 35 28
Incorrect Charge Rate	<ul style="list-style-type: none"> (1) Rates Set Incorrectly (2) Fixed Temperature Set Incorrectly (3) Charge Curve Incorrect (4) Battery A.H. Not Equal To Charger A.H. (5) Battery Has Incorrect Size BID (6) Bad Control Board (7) BID Not Programmed Properly (8) Inadequate Ventilation (9) Charger Fans Not Operating 	<ul style="list-style-type: none"> 26 27 25 26 28 4 28 15 18
Doesn't Shutdown When Battery Is Disconnected	<ul style="list-style-type: none"> (1) Control Set For Forming Cycles (2) Bad Control Board (3) Bad Internal Charger Primary Board 	<ul style="list-style-type: none"> 35 4 5
Erratic Operation	<ul style="list-style-type: none"> (1) Bad Control Board (2) Bad Harness/Connection - Loose or Incorrect (3) Bad Power Connection (4) Bad Output Cable Connector (5) Moisture Inside Cabinet (6) Lack of Maintenance (7) High Ambient Temperature 	<ul style="list-style-type: none"> 4 3 41 13 42 43 16
Meter Reading Wrong (V/C)	<ul style="list-style-type: none"> (1) Bad Output Connector (2) Bad Harness/Connection - Loose or Incorrect (3) Internal Power Connection (4) Bad Control Board 	<ul style="list-style-type: none"> 13 3 41 4

SYMPTOM	PROBABLE CAUSES	ACTION STEPS
Meter Reading Wrong (Amps)	(1) Bad Output Connector (2) Bad Harness/Connections – Loose Or Incorrect (3) Internal Power Connection (4) Bad Control Board (5) Shunt Calibration needed	13 3 41 4 44
High Input Current	(1) Bad Internal Charger Primary Board (2) AC Supply (3) Bad Control Board (4) Bad Harness/Connections – Loose Or Incorrect	5 1 4 3
Display reads - Curve Error Fault	(1) Bad Harness/Connections – Loose Or Incorrect (2) Bad Control Board (3) Bad Internal Charger Primary Board (4) Charge Curve	3 4 5 25
Display reads - Backup Timer Fault	(1) Fixed Temperature Set Incorrectly (2) BID A.H. > Charger A.H. (3) Bad Output Cable Connector (4) Incorrect Charge Curve Setting (5) Bad Battery (6) Bad BID	27 26 13 25 32 28
Display reads - Manual Stop Fault	(1) Someone Pressed Manual Stop Button (2) Bad Connection (Keypad-Control) (3) Bad Keypad (4) Bad Control Board	45 6 7 4
Display reads - Low Current Fault	(1) Fixed Temperature Set Incorrectly (2) Bad Harness/Connections – Loose Or Incorrect (3) Battery Not Fully Formed (4) Bad Battery (5) BID A.H. > Charger A.H. (6) Bad Internal Power Connection (7) AC Supply (8) Bad AC Fuse (9) Output Fuse Bad (10) Bad Control Board (11) Bad Internal Charger Primary Board (12) Bad Heat Sink Thermostat, if equipped	27 3 46 32 26 41 1 2 11 4 5 19

SYMPTOM	PROBABLE CAUSES	ACTION STEPS
Display Reads - Low Battery Fault	(1) Fixed Cell Setting Incorrect (2) Bad Harness/Connections – Loose Or Incorrect (3) Bad Battery (4) Bad Control Board (5) Bad Output Cables/Connector (6) BID Not Programmed Properly	47 3 32 4 13 28
Display Reads - High Battery Fault	(1) Fixed Cell Setting Incorrect (2) Bad Battery (3) Bad Control Board (4) BID Not Programmed Properly	47 32 4 28
Display Reads - Setup Error Fault	(1) Cell Size Setting Has Been Changed On Control Board (2) A.H. Resistor Has Been Changed On Control Board (3) Bad Keypad Connection (Keypad-Control) (4) Bad Keypad (5) Bad Control Board	48 49 6 7 4
Display Reads - Check AC Power	(1) Intermittent AC Fail (Supply) (2) Bad Harness/Connection – Loose Or Incorrect (3) Bad Control Board	1 3 4
Display Reads - Overtemperature Fault	(1) See “Unit smells hot” in this chapter	-
Display Reads - Phase Error Fault	(1) Bad Internal Charger Primary Board (2) AC Supply (3) Bad Control Board (4) Bad Harness/Connections – Loose Or Incorrect	5 1 4 3
Display Reads - DIDT Fault	(1) Bad Battery (2) Bad Control Board (3) Bad BID	32 4 28

SYMPTOM	PROBABLE CAUSES	ACTION STEPS
Display Reads - High Amp Hour Fault	(1) Bad Battery	32
	(2) Bad Control Board	4
	(3) Bad BID	28
Display Reads - Low Voltage Fault	(1) Bad Battery	32
	(2) Bad Control Board	4
	(3) Bad Internal Power Connection	41
	(4) Bad Harness/Connections - Loose or Incorrect	3
Unable to download Datalink records	(1) Bad Harness/Connections - Loose or Incorrect	3
	(2) Keypad connected improperly	6
	(3) Bad Keypad	7
	(4) PC Setup/Operating System	50

Action Steps

1. Reference the INSTALLATION chapter (pg. 4-1).
2. Disconnect AC power to the charger and replace the AC fuse. Reapply AC power to the charger. If the fuse (s) blows instantly, the primary PCB is probably bad. Contact the factory for replacement.
3. A bad wire harness connection can cause many different problems. Check the ribbon cable connections, make sure they are properly seated in their housings. Check the wire bundles and connectors, make sure they are connected well and crimped properly. Inspect all wiring crimp connected to the primary board. They should all be fully inserted and tight.
4. To check the board for proper operation, first check the S1 dip switch selections. They should match the charger maximum cell size, check the nameplate. Check DC voltages (+/- 5%) between J1-4 and the following: E34 = 4.85, E33 13.00, J1-1 = 5.00. If the charger still does not operate properly even though the above checks are correct, the control may need to be replaced.
5. The primary board is the large PCB that is on the lower left (both for dual engine units) side of the unit. It has several functions that include providing power to the control. Check that the 2 green LEDs are lit when AC power is applied. If they are not, remove power and check fuses FS1 and FS2. Contact the factory for any further details.
6. Open the charger door and check the keypad connection at J3 (right side of pcb). Make sure that the cable is not twisted and is fully engaged.
7. Once step 6 has been checked, with no battery connected to the charger, press any of the number keys. The display should display data represented by that key. If it does not, the keypad is bad.
8. Temporarily shut down any equipment on the same voltage supply line and see if the charger starts to respond normally. If the charger does, then check all grounds going to the equipment that is shut down. If the problems still exist, then return power to all the other equipment and call your local Ametek representative.
9. Measure the AC supply voltage coming into the charger to confirm that it matches the charger input voltage requirements. Also see Action #1.
10. On the left side of the display, a 16 pin header connector should be mated with a 16 position receptacle on the main control pcb. Check for full insertion and proper alignment.
11. Use an Ohmmeter and measure directly across the DC fuse. A good fuse will measure almost (0) Ohms and a bad one will measure a very high resistance, in the megohm range or greater. If for some reason a DC Fuse measures somewhere in between, replace the DC Fuse and send it in to your local Ametek representative.
12. Remove the charger side cover(s) to expose where the output cables connect to the charger. The black (Negative) output cable goes into the charger and connects to bus bar adjacent to the DC output fuse. The red (Positive) output cable goes into the charger and connects to the bus bar that is mounted to the top of the output transformer.
13. Make sure the output connector does not have any cracks on its casing that could result in a short. Make sure the output cable lugs are making a good connection with the battery connector. You will see traces of pitting on the lug surface from arcing if there isn't a good connection. This could be the result of a weak retainer clip in the connector or lugs that were soldered on incorrectly. If the lugs had too much heat applied to them when the cables were soldered on, the solder will wick up the cable and make it very stiff. When they are inserted into the connector, the stiff cable forces the retainer clip down and creates poor connection between the battery connector and the charger connector.
14. For 6 through 24 cell chargers, a jumper loop should be between pins 3 and 4 at the J8 connector on the left side of the control. For 36 and 40 cell units, the jumper should be from J8-2 to J8-4.
15. Refer to the INSTALLATION chapter and go to the paragraph labeled "LOCATION". This will define the guide lines. If a charger has inadequate ventilation, many different problems can occur. If a charger runs under extreme temperatures, any component inside the charger could fail prematurely.
16. An extremely high ambient temperature can cause many different problems. If a charger runs under extreme Temperatures, any component inside the charger could fail prematurely.
17. If the AH jumper is incorrect for the charger, it will cause the unit to charge at rates either higher or lower than Nameplate rating.

Check the fan power wiring on the primary pcb. The connector is on the upper left side of the board and is labeled J4. The 2 fan wiring connections are labeled J4-1 and J4-2.

19. Remove power from the charger, and then open the charger door. Let the unit cool to room temperature. Find J5 connector on the center top side of the primary pcb. Using test probes, connect to positions 1 and 2. Using an ohmmeter, check the resistance across the terminals, it should be approximately 10,000 ohms @ 77°F. Remove the test leads and repeat for positions 3 and 4.
20. A faulty lift interrupt on a lift truck can cause the battery to be or under charged. Check the interrupt voltage of the interrupt following the procedures found in your truck and/or lift interrupt operator's manual(s).
21. When it is necessary to stop the charge cycle before charge complete, always terminate the charge cycle by pressing the STOP key before disconnecting the battery from the charger.
22. If the application requires a larger AH battery than is presently in use, the only long term solution is to replace the battery with one of the proper AH rating.
23. Take Specific Gravity readings and measure Cell Voltages. If acid has been spilled or the battery has been extremely heated, it is possible that a battery's capacity could be greatly reduced, and the acid is not capable of increasing to the battery nameplate rating.
24. The proper equalize schedule is one that is tailored to the specific battery and charger operation. The EC2000 Auto Equalize feature can be used to automate the equalize schedule.
25. Using the Review feature of the control (See the Control Features chapter), check the charge curve setting of the charger. If it does not match the Battery Type (Standard, Sealed, Custom, Etc.), reprogram the control to the proper curve. (Refer to the Programming Your EC2000 Control chapter of this manual).
26. Using the Review feature of the control (See the Control Features chapter of this manual), check the Fixed AH setting of the charger. If it does not match the battery nameplate rating of the battery (it should be within 20% of the battery nameplate rating), reprogram the control to the proper Fixed AH rating (Refer to the Programming Your EC2000 Control chapter of this manual). If this is not possible due to the maximum rating of the charger, a larger charger should be used.
27. Refer to Program chapter. Go to function number 37 and confirm that the control is set for the correct Fixed Temperature Setting. If not, enter the correct setting.
28. The BID module communicates battery temperature, cell size, ampere hour, BID no., and type to the charger. A non-functioning or incorrectly programmed BID can cause charging and/or battery problems. Using the EC2000 Review Features (See the EC2000 Review Features in this manual), check the review items listed above. Replace a non-functioning or incorrectly programmed module with a new one.
29. Using the Review feature of the control (See the Control Features chapter of this manual), check the Fixed AH setting of the charger. If it does not match the battery nameplate rating of the battery (it should be within 20% of the battery nameplate rating), reprogram the control to the proper Fixed AH rating (Refer to the Programming Your EC2000 Control chapter of this manual). If this is not possible due to the maximum rating of the charger, a larger charger should be used.
30. Not enough charging time - In cases where opportunity charging is taking place, more time charging may be needed to keep the battery within its proper operating range. Be sure that the battery is charged per the users operations guide-lines. Those procedures may need to be adjusted to allow for more charging time or less battery load.
31. Specific Gravity readings vary with the temperature of the electrolyte. To temperature correct the Specific Gravity readings to match the nameplate ratings of the battery, use the following rule of thumb: +1 S.G. point per 3°F that the electrolyte temperature exceeds 77°F.
32. Take Specific Gravity readings and measure Cell Voltages. If acid has been spilled or the battery has been extremely heated, it is possible that a battery's capacity could be greatly reduced, and the acid is not capable of increasing to the battery nameplate rating.
33. The proper equalize schedule is one that is tailored to the specific battery and charger operation. The EC2000 Auto Equalize feature can be used to automate the equalize schedule. (See the EC2000 Features chapter of this manual.)

34. If battery electrolyte temperatures are well below 32°F, the Eclipse will not be able to adequately charge the battery. Battery insulation or heaters would be required to keep the battery electrolyte temperatures close to 32°F.
35. If the control is set to perform forming cycles, DV/DT termination is disabled, and the low current shutdown is disabled. To return to normal operation, program the control to "00" Forming Cycles (See the Programming section of your EC2000 Control chapter of this manual).
36. Program the control to DV/DT charge termination (See the Programming Your EC2000 Control chapter of this manual).
37. A faulty lift interrupt on a lift truck can cause the battery to be over or under charged. Check the interrupt voltage of the interrupt following the procedures found in your truck and/or lift interrupt operator's manual (s).
38. If fully discharged batteries are desired for efficient operations, lift interrupts can be installed on the trucks to allow the operators to recognize a fully discharged battery.
39. In opportunity charging applications, higher than normal battery temperatures should be expected. In cases where the temperature is exceeding a reasonable value, utilize the battery cooling feature of the EC2000 Control or adjust the the battery use versus charging schedule to allow for lighter loads on the battery. In a standard charging mode, a cool down can be programmed into the EC2000 Control to add a specific cool down time between charge termination and the signaling of charge complete (See the Programming Your EC2000 Control chapter of this manual). A delayed start can be programmed into the EC2000 Control to add a specified delay time between battery connection and the start on the charge (See the Programming Your EC2000 Control chapter of this manual).
40. Battery is being discharged at too high (fast) of a rate. Consult the battery manufacturer or distributor for applications assistance.
41. Do a continuity or resistance test. Check for connection points that visually appear to have been exposed to extreme heat. Any connections that appear loose or overheated must be re-lugged and rechecked.
42. Disconnect the charger from the battery and the input AC. Blow out the charger with compressed air, and allow the unit to set unused for 1 to 2 weeks in a warm dry environment (as hot, up to 104°F) and dry as possible.
43. Refer to the MAINTENANCE chapter in the manual. Electrical parts tend to attract dust and dirt after a long period of time, which can cause parts to fail prematurely.
44. Connect a 50% to 100% discharged battery to the charger. Within 3 minutes of when charging begins, press and hold the "program" key for 5 seconds, then release it. The lower line of the display should change to "shunt calibration". Using the up and down arrow keys, adjust the charger output current shown on the EC2000 display to match a DC current clamp or calibrated test shunt. Press the "program" key again when the process is complete.
45. When it is necessary to stop the charge cycle before charge complete, always terminate the charge cycle by pressing STOP key before disconnecting the battery from the charger.
46. Program the forming cycles feature of the EC2000 Control to the number of cycles required to properly form the battery. (See the Programming Your EC2000 chapter of this manual).
47. Program the EC2000 Control to Multi-cell mode "ON" or program the Fixed Cell setting to the proper cell size for your battery. (See the Programming Your EC2000 chapter of this manual).
48. Set the Control PCB cell size dip switches to match the charger nameplate cell size and cycle AC power. Reset by pressing both arrow keys simultaneously until the display resets.
49. Replace the ampere hour jumper with one that matches the nameplate AH rating of the charger and cycle AC power. See the parts list included in this manual. Reset by pressing both arrow keys simultaneously until the display resets.
50. Contact Factory for assistance.

TYPE	DIAGRAM	OUTLINE
1 PAK	198533	198536
2 PAK	198554	
2 PAK W/DUAL CABLES	198555	
2 CIRCUIT	198504	

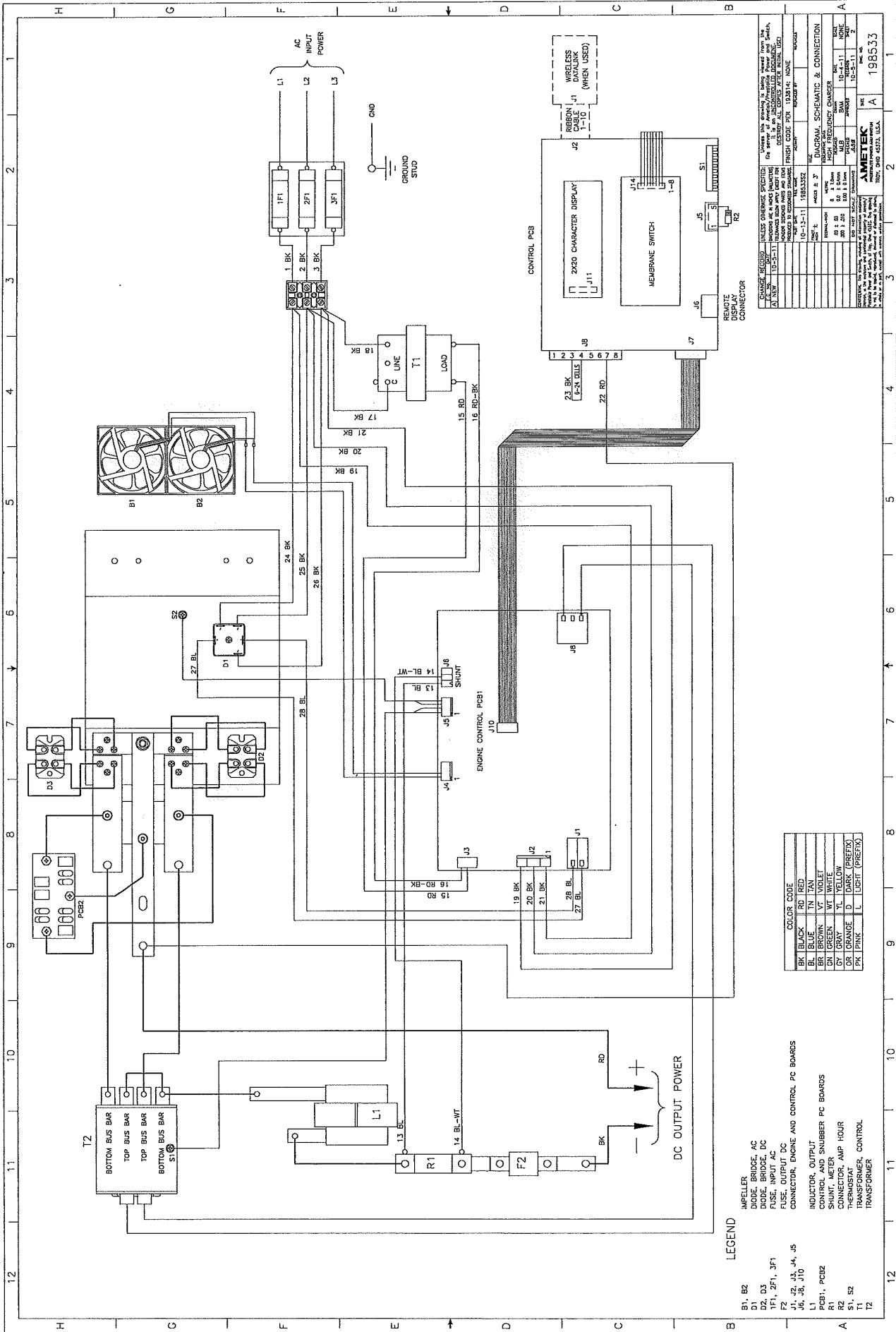

LEGEND

- B1, B2 IMPELLER
- D1 DIODE, BRIDGE, AC
- D2, D3 DIODE, BRIDGE, DC
- F1, F2 FUSE, INPUT AC
- F3 FUSE, OUTPUT DC
- J1, J2, J3, J4, J5 CONNECTOR, ENGINE AND CONTROL PC BOARDS
- J6, J7, J8 CONNECTOR, ENGINE AND CONTROL PC BOARDS
- L1 INDUCTOR, OUTPUT
- R1 CONTROL AND SHAFTER PC BOARDS
- R2 SHUNT, METER
- S1 CONNECTOR, AMP HOUR
- S2 THERMISTAT
- T1 TRANSFORMER, CONTROL
- T2 TRANSFORMER

COLOR	CODE
BK	BLACK
BL	BLUE
BR	BROWN
GN	GREEN
GY	GRAY
OR	ORANGE
PK	PINK
RD	RED
TR	TAN
VT	VIOLET
WT	WHITE
YL	YELLOW
DRK	DARK (GREEN)
LGHT	LGHT (GREEN)

CHANGE RECORD	UNLESS OTHERWISE SPECIFIED	DATE
1	DESIGN	1985.33
2	REVISED	
3	REVISED	
4	REVISED	
5	REVISED	
6	REVISED	
7	REVISED	
8	REVISED	
9	REVISED	
10	REVISED	
11	REVISED	
12	REVISED	

DIAGRAM, SCHEMATIC & CONNECTION	DATE
1	1985.33
2	
3	
4	
5	
6	
7	
8	
9	
10	
11	
12	

AMETEK
 1985.33
 1985.33



WARRANTY

AMETEK/PRESTOLITE POWER "ECLIPSE II", "ECLIPSE II PLUS", ECLIPSE II SLIMLINE, ECLIPSE II-2 CIRCUIT, and All ECLIPSE II Series-HE (CEC) units INDUSTRIAL BATTERY CHARGERS

Ametek/Prestolite Power (hereinafter called "Prestolite") warrants that each new and unused Industrial Battery Charger manufactured and supplied by it is of good workmanship and is free from any inherent mechanical defects, provided that (1) the product is installed and operated in accordance with generally accepted industrial standards and in accordance with the printed instructions of Prestolite outlined in the product Owner's Manual, (2) the product is used under normal conditions for which designed, (3) the product is not subjected to misuse, negligence or accident, and (4) the product receives proper care, protection and maintenance under supervision of competent personnel. This warranty is subject to the following provisions:

AC SUPPLY INPUT CONDITIONS:

- Supply voltage should not exceed +/-10% of rated input voltage value.
- Consistent power should be provided with fluctuations not to exceed 1200VAC (850Vrms) for a duration longer than 25 microseconds.

1. **PRODUCT AND PARTS WARRANTED.** Subject to the exceptions listed below each Industrial Battery Charger is warranted for a specific period of time commencing from the date of its shipment by Prestolite, provided the charger is used in accordance with Prestolite's published performance rating for the unit involved. The exceptions to this warranty are as follows:

a) Terms and conditions for warranty coverage:

FULL COVERAGE - LABOR, TRAVEL, MILEAGE & PART REPLACEMENT	5-years
---	---------

b) Warranty Expense Limitation: The maximum warranty expense Prestolite will incur for any Battery Charger will be limited to the original purchase price of the Battery Charger.

c) Primary switch contacts, fuses, bulbs and filters are not warranted unless found to be defective prior to use.

- COMMENCEMENT OF WARRANTY TIME PERIODS.** The warranty periods indicated in the Warranty Schedule shall commence on the date of shipment by Prestolite.
- PERSONS COVERED BY WARRANTY.** Prestolite extends this warranty only to the purchaser of new equipment from Prestolite or one of its authorized distributors. The products purchased under this agreement shall be used exclusively by the buyer and its employees and by no other persons; and therefore, there shall be no third-party beneficiary to this warranty.
- LIMITATION OF REMEDY.** The existence of claimed defects in any product covered by this warranty is subject to Prestolite's factory inspection and judgement. Prestolite's liability is limited to repair of any defects found by Prestolite to exist or, at Prestolite's option, the replacement of the defective product F.O.B. factory after the defective product has been returned by the purchaser at its expense to Prestolite's shipping place. Replacement and exchange parts will be warranted for the remainder of the original Industrial Battery Charger Warranty or for a period of ninety (90) days, whichever is greater. Modifications or repairs performed by anyone other than Prestolite or an Authorized Service Provider will VOID all warranty.
- USE OF DEFECTIVE PRODUCT.** Continued use of an Industrial Battery Charger after discovery of a defect VOIDS ALL WARRANTIES.
- ALTERED EQUIPMENT.** Except as authorized in writing, the warranty specified does not cover any equipment that has been altered by any party other than Prestolite.

THIS WARRANTY IS GIVEN AND ACCEPTED IN LIEU OF ALL OTHER WARRANTIES, WHETHER EXPRESS OR IMPLIED, INCLUDING WITHOUT LIMITATION ANY WARRANTIES OF MERCHANTABILITY OR FITNESS FOR A PARTICULAR PURPOSE, OTHER THAN AS EXPRESSLY SET FORTH HEREIN. IN NO EVENT SHALL PRESTOLITE BE LIABLE FOR ANY ANTICIPATED OR LOST PROFITS, SPECIAL, DIRECT, INDIRECT OR INCIDENTAL DAMAGES, CONSEQUENTIAL DAMAGES, TIME CHARGES OR OTHER COMMERCIAL EXPENSES OR LOSSES, AND BUYER ASSUMES ALL RISK AND LIABILITY RESULTING FROM USE OF THE GOODS. PRESTOLITE DOES NOT AUTHORIZE ANY REPRESENTATIVE OR OTHER PERSON TO ASSUME ON BEHALF OF PRESTOLITE ANY OTHER LIABILITY IN CONNECTION WITH THE SALE OR USE OF THE GOODS SOLD, AND THERE ARE NO ORAL AGREEMENTS OR WARRANTIES COLLATERAL TO OR AFFECTING THIS WRITTEN WARRANTY.

WARNING

At all times, safety must be considered an important factor in the installation, servicing and operation of the product and skilled, qualified technical assistance should be utilized.

AMETEK/PRESTOLITE POWER - TROY, OHIO USA

Data Sheet: 1158
Index: 040120
Replaces: 040115

