

# **OWNER'S MANUAL 193111-055**

Revised March 1, 2008

---

**IMPORTANT:** Read these instructions before installing, operating, or servicing this system.

---

## **ACCU-CHARGER**

**Silicon Diode Ferroresonant  
Transformer type  
Battery Charger**

**DO NOT DESTROY**

**AMETEK/PRESTOLITE POWER , TROY, OHIO 45373-1099, U.S.A.**



---

<b>INTRODUCTION</b> .....	<b>1</b>
How to use this Manual .....	1-1
Equipment Identification .....	1-1
Receipt of Equipment .....	1-1
<b>SAFETY INSTRUCTIONS AND WARNINGS</b> .....	<b>2</b>
<b>DESCRIPTION OF EQUIPMENT</b> .....	<b>3</b>
<b>INSTALLATION</b> .....	<b>4</b>
Location .....	4-1
Environmental Characteristics .....	4-1
Grounding .....	4-1
Line Voltage Changeover Instructions .....	4-2
Line Connections to Battery Charger .....	4-2
Charging Cable Connectors .....	4-3
Pre-operation Checks .....	4-3
<b>OPERATION</b> .....	<b>5</b>
Preliminary .....	5-1
Normal or Daily Charge .....	5-1
Equalize or Weekend Charge .....	5-1
Manual Stop .....	5-2
Battery Discrimination .....	5-2
Refresh Charge .....	5-2
Backup Timer Shutdown .....	5-2
Battery Disconnect Shutdown .....	5-3
Low Current Shutdown .....	5-3
AC Power Fail .....	5-3
<b>MAINTENANCE</b> .....	<b>6</b>
Inspection and Cleaning .....	6-1
Lubrication .....	6-1
Charging Rate Adjustment .....	6-1
Fuse Replacement .....	6-2
Silicon Diode Testing .....	6-2
Capacitor Testing .....	6-3
Troubleshooting .....	6-4
<b>OPTIONS</b> .....	<b>7</b>
Parallel Charging — Option 002 .....	7-1
Series Charging — Option 003 .....	7-1
Remote Charge Control — Option 101 .....	7-2
Fused Disconnect Switch — Option 500 .....	7-2
<b>PARTS LIST</b> .....	<b>8</b>
<b>DIAGRAMS</b>	
<b>WARRANTY</b>	

# INTRODUCTION

## How To Use This Manual

**IMPORTANT:** It is especially important that all charger internal components be kept clean and dry, and all electrical connections as tightened as instructed in the Maintenance chapter of this manual. Replace any precautionary or instruction label that cannot be easily read.

Throughout this manual, the words **WARNING**, **CAUTION**, and **NOTE** may appear. Pay particular attention to the information provided under these headings. These special annotations are easily recognized as follows:

**WARNING** gives information regarding possible personal injury. Warnings will be enclosed in a box such as this.

**CAUTION** refers to possible equipment damage. Cautions will be shown in bold type.

*NOTE* offers helpful information concerning certain operating procedures. Notes will be shown in italics.

## Equipment Identification

The unit's identification number (specification, model, serial number) usually appears on a nameplate attached to the front panel.

## Receipt Of Equipment

When you receive the equipment, check it against the invoice to make sure it is complete and inspect the equipment for possible damage due to shipping. If there is any damage, notify the carrier immediately to file a claim. Furnish complete information concerning damage claims or shipping errors to the company shown on the cover of this manual. Include all equipment identification numbers and group part numbers (if any) as described above along with a full description of the parts in error.

Move the equipment to the site of installation before uncrating. Use care to avoid damaging the equipment when using bars, hammers, etc., to uncrate the unit.

Additional copies of this manual may be purchased by contacting the company shown on the cover of this manual. Include the Owner's Manual number and equipment identification numbers.

# SAFETY INSTRUCTIONS AND WARNINGS

## FOR OPERATION OF BATTERY CHARGING EQUIPMENT

**IMPORTANT – READ AND UNDERSTAND THESE INSTRUCTIONS. DO NOT LOSE THEM. ALSO READ OPERATING/INSTRUCTION MANUAL BEFORE INSTALLING, OPERATING, OR SERVICING THIS EQUIPMENT.**

### A. General

Battery charging products can cause serious injury or death, or damage to other equipment or property, if the operator does not strictly observe all safety rules and take precautionary actions.

Safe practices have developed from past experience in the use of charging equipment. These practices must be learned through study and training before using this equipment. Anyone not having extensive training in battery charging practices should be taught by experienced operators.

Only qualified personnel should install, use, or service this equipment.

### B. Shock Prevention

Bare conductors, or terminals in the output circuit, or ungrounded, electrically-live equipment can fatally shock a person. To protect against shock, have competent electrician verify that the equipment is adequately grounded and learn what terminals and parts are electrically HOT.

The body's electrical resistance is decreased when wet, permitting dangerous current to flow through the body. Do not work in damp area without being extremely careful. Stand on dry rubber mat or dry wood and use insulating gloves when dampness or sweat cannot be avoided. Keep clothing dry.

1. Installation and Grounding of Electrically Powered Equipment – Electrical equipment must be installed and maintained in accordance with the National Electrical Code, NFPA 70, and local codes. A power disconnect switch must be located at the equipment. Check nameplate for voltage and phase requirements. If only 3-phase power is available, connect *single-phase* equipment to only two wires of the 3-phase line. DO NOT CONNECT the equipment grounding conductor (lead) to the third live wire of the 3-phase line as this makes the equipment frame electrically HOT, which can cause a fatal shock.

If a grounding lead (conductor) is part of the power supply cable, be sure to connect it to a properly grounded switch box or building ground. If not part of the supply cable, use a separate grounding lead (conductor). Do not remove a ground prong from any plug. Use correct mating receptacles. Check ground for electrical continuity before using equipment.

The grounding conductor must be of a size equal to or larger than the size recommended by Code or in this manual.

2. Charging Leads – Inspect leads often for damage to the insulation. Replace or repair cracked or worn leads immediately. Use leads having sufficient capacity to carry the operating current without overheating.
3. Battery Terminals – Do not touch battery terminals while equipment is operating.
4. Service and Maintenance – Shut OFF all power at the disconnect switch or line breaker *before* inspecting, adjusting, or servicing the equipment. Lock switch OPEN (or remove line fuses) so that the power cannot be turned ON accidentally. Disconnect power to equipment if it is to be left unattended or out of service.

Disconnect battery from charger. Measure voltage on capacitors and discharge through an insulated screwdriver if there is any voltage reading.

Keep inside parts clean and dry. Dirt and/or moisture can cause insulation failure. This failure can result in high voltage at the charger output.

### C. Burn and Bodily Injury Prevention

The battery produces very high currents when short circuited, and will burn the skin severely if in contact with any metal conductor that is carrying this current. Do not permit rings on fingers to come in contact with battery terminals or the cell connectors on top of the battery.

Battery acid is very corrosive. Always wear correct eye and body protection when near batteries.

### D. Fire and Explosion Prevention

Batteries give off explosive flammable gases which easily ignite when coming in contact with an open flame or spark. Do not smoke, cause sparking, or use open flame near batteries. Charge batteries only in locations which are clean, dry, and well ventilated. Do not lay tools or anything that is metallic on top of any battery. All repairs to a battery must be made only by experienced and qualified personnel.

### E. Arcing and Burning of Connector

To prevent arcing and burning of the connector contacts, be sure the charger is OFF before connecting or disconnecting the battery. (If the charger is equipped with an ammeter, the ammeter should not indicate current flow.) Always connect battery before turning charger ON.

### F. Medical and First Aid Treatment

First aid facilities and a qualified first aid person should be available for each shift for immediate treatment of electrical shock victims.

**EMERGENCY FIRST AID: Call physician and ambulance immediately. Use First Aid techniques recommended by the American Red Cross.**

**DANGER: ELECTRICAL SHOCK CAN BE FATAL. If person is unconscious and electric shock is suspected, do not touch person if he or she is in contact with charging leads, charging equipment, or other live electrical parts. Disconnect (open) power at wall switch and then use First Aid. Dry wood, wooden broom, and other insulating material can be used to move cables, if necessary, away from person. IF BREATHING IS DIFFICULT, give oxygen. IF NOT BREATHING, BEGIN ARTIFICIAL BREATHING, such as mouth-to-mouth. IF PULSE IS ABSENT, BEGIN ARTIFICIAL CIRCULATION, such as external heart massage.**

IN CASE OF ACID IN THE EYES, flush very well with clean water and obtain professional medical attention immediately.

### G. Equipment Warning Labels

Inspect all precautionary labels on the equipment. Order and replace all labels that cannot be easily read.

# DESCRIPTION OF EQUIPMENT

## Charger

The basic charging circuit is the silicon diode, rectifier-type with ferroresonant transformer (s). This ferroresonant transformer design regulates charging current by allowing the battery to determine its own charge cycle rate in accordance with its state of discharge. It provides a constantly-tapering charge that eliminates the possibility of overcharging, even with line voltage variations of  $\pm 10\%$ . Single-phase input chargers have one transformer, three-phase input chargers have three. The charger is internally protected from overload and short circuits.

When charging lead acid batteries, with the same number of cells and ampere-hour capacity as shown on charger nameplate, the charging time will be approximately 8 hours. Batteries of smaller or larger ampere-hour capacities can also be charged, but will require shorter or longer charging, respectively.

## Charge Control

The AC500 Control is provided as the standard charger control. It utilizes either a voltage/time (VT) charge termination or a patented  $pT/dV/dT$  charge termination technique which eliminates excessive gassing by returning approximately 107% of the amp-hours removed from the battery.

Features of the AC500 Control include manual equalize, manual stop, back-up timer protection, two charge termination methods, 80% voltage point selection, high and low battery voltage discrimination, and AC power fail recovery.

The AC500 Control is "matched" to the output voltage of the charger by means of a printed circuit board mounted DIP switch. It will operate on 6, 12, 18, 24, 36, and "optional" cell batteries. "Optional" is provided to accommodate batteries between 6 and 36 cells that are not listed above.

The status of a normal charge cycle is indicated by the four LEDs on the front panel. The "80% Charged" LED will light when the battery voltage reaches the 80% charged voltage. This voltage may be 2.37 volts/cell or 2.45 volts/cell nominal, depending on the status of DIP switch S1-7. See the AC500 Setup chapter of this manual. The "Charge Complete" LED will light only if the battery has completed the charge cycle and is ready for use. The "Abnormal Shutdown" LED will light if the charger terminates a charge prematurely. See the Troubleshooting chapter of this manual to determine the cause of the fault. The "Equalize" LED will light solid when a equalize charge is requested by pressing the EQUALIZE push button. The "Equalize" LED will flash when the charger is equalizing the battery.

**WARNING: Do not connect a battery to this charger if any LED is lit. Do not disconnect a battery from this charger while a charge is in progress. Otherwise, arcing and burning of connector parts or a battery explosion may result. Batteries produce explosive gases. Keep sparks, flame, and cigarettes away. Ventilate when charging in an enclosed area. Always shield eyes when working near batteries.**

# INSTALLATION

## Location

For best operating characteristics and longest unit life, take care in selecting an installation site. Avoid locations exposed to high humidity, dust, high ambient temperature, or corrosive fumes. Moisture can condense on electrical components, causing corrosion or shorting of circuits (especially when dirt is also present).

Adequate air circulation is needed at all times in order to assure proper operation. Provide a minimum of 6 inches of free air space at rear and sides of the unit. Make sure that ventilation openings are not obstructed.

Always remove the charger shipping skid from the unit before installation. The charger must be installed over a noncombustible surface such as concrete or metal. Keep the charging area clear of all combustible material such as wood, paper, and cloth.

**WARNING: SPARKS OR MOLTEN METAL falling through open bottom can cause fire or explosion.**

- **Install over noncombustible material such as concrete or metal.**
- **Keep charging area clear of combustible material.**

## Environmental Characteristics

Operating Characteristics	0°C to 40°C (32°F to 104°F)
Operating Altitude	To 2000 Meters (6562 Feet)
Operating Humidity	80% up to 31°C, decreasing to 50% at 40°C, non-condensing  80% up to 88°F decreasing to 50% at 104°F, non-condensing

## Grounding

The frame of the power source must be grounded for personnel safety. Where grounding is mandatory under state or local codes, it is the responsibility of the user to comply with all applicable rules and regulations. Where no state or local codes exist, it is recommended that the National Electrical Code be followed.

In addition to the usual function of protecting personnel against the hazard of electrical shock due to fault in the equipment, grounding serves to discharge the static electrical charges which tend to build up on the surfaces of equipment. These static charges can cause painful shock to personnel, and can lead to the erroneous conclusion that an electrical fault exists in the equipment.

If a charger is to be connected to the AC power supply with a flexible jacketed cable, one having a separate grounding conductor should be used. When included in cable assembly, grounding conductor will be green, green with a yellow stripe, or bare. When connecting input power to charger (as instructed in Line Connection to Battery Charger section of this manual), connect grounding conductor to equipment grounding terminal (stud with a green nut and a cup washer and identified by symbol  $\equiv$ ), taking care to make a good electrical connection. Connect other end of grounding conductor to the system ground.

If, for any reason, an input cable which does not include a grounding conductor is used, the equipment must be grounded with separate conductor. Minimum size and color coding requirements must be in accordance with any applicable state or local code, or the National Electrical Code.

If metallic armored cable or conduit is used, the metal sheathing or conduit must be effectively grounded as required by state or local code, or the National Electrical Code.

If a system ground is not available, the charger frame must be connected to a driven ground rod (at least 8 ft [2438 mm] long), or to a water pipe that enters the ground not more than 10 ft (3048 mm) from the charger. A grounding conductor must be connected to the rod or pipe in a manner that will assure a permanent and effective ground. The conductor must be sized in accordance with any applicable state or local code, or by the National Electrical Code. If in doubt, use the same size conductor as is used for the conductors supplying power to the charger.

**WARNING: ELECTRIC SHOCK HAZARD – Under no circumstance should you use a grounding conductor with a current carrying capacity less than the ampere rating shown in Table 4-1.**



LINE AMPS	DISCONNECT SWITCH *	BRANCH FUSE SIZE (AMPERES)	COPPER CABLE SIZE AWG **	
			POWER	GROUND
0-2.5	30A	5	No. 14	No. 14
2.6-4.5	30A	7	No. 14	No. 14
4.6-7.5	30A	10	No. 14	No. 14
7.6-12	30A	15	No. 14	No. 14
12.1-16	30A	20	No. 12	No. 12
16.1-18	30A	25	No. 10	No. 10
18.1-22	30A	30	No. 10	No. 10
22.1-24.5	60A	35	No. 8	No. 10
24.6-32.5	60A	40	No. 8	No. 10
32.6-40	60A	50	No. 8	No. 10
40.1-45	60A	60	No. 6	No. 10
45.1-57.5	100A	80	No. 4	No. 8
57.6-78	100A	100	No. 2	No. 8
78.1-102.5	200A	125	No. 2	No. 6
102.6-135	200A	150	No. 1/0	No. 6

**Table 4-1 Recommended AC Input and Branch Fusing**

The above table (Table 4-1) is based on 75°C (167°F) rated conductors and 40°C (104°F) ambient temperatures. Refer to National Electrical Code (2008) Tables 310-16 corrected to 40°C (104°F).

\* For 115, 208, and 230-volt lines, use 250-volt disconnect switch.  
 For 440-480, 575-volt lines, use 600-volt disconnect switch.

\*\* Two conductors and ground conductor required for single phase.  
 Three conductors and ground conductor required for three phase.

Recommended minimum size of grounding conductors (based on National Electrical Code 2008 – Table 250-95).

### Line Voltage Changeover Instructions

1. Determine if the charger is connected for available line voltage. A label located near AC input terminals is marked with the AC voltage for which the charger is factory connected.
2. If charger is not connected correctly, check serial nameplate to determine that charger is equipped to be connected for available line voltage. If charger is suitably equipped, make voltage changeover connections by following instructions on AC INPUT label inside charger.
3. If charger is reconnected, check input fuse (s) ratings with ratings specified on label and replace if necessary.

**CAUTION: INCORRECT CONNECTIONS AND INCORRECT FUSE SIZE can damage this equipment. Follow voltage changeover instructions carefully.**

### Line Connections to Battery Charger

Follow local code requirements if different than instructions in this manual.

1. Turn charger OFF.
2. Be sure charger is connected correctly for available line voltage as instructed above.
3. On charger nameplate, note the AC input amperes corresponding to the line voltage to which charger is to be connected. Use that ampere value to select the proper disconnect switch, fuse, and power cable sizes from Table 4-1. A “WARNING” label inside charger also lists fuse sizes for each line voltage (circled fuse rating is required for internal line voltage connections made at factory).

4. Route AC power input cable in through knock-out provided in side panel of charger cabinet. Securely fasten cable wires to a power input terminal inside charger. Refer to Grounding section of this manual for proper connection of grounding conductor. (Charger cabinet top or side panel, or both, may have to be removed to provide access to terminal block.)
5. With disconnect switch (on AC input power line) in "OPEN" or "OFF" position, connect power cable coming from charger, to the switch. Install fuses in switch.

## Charging Cable Connectors

If connectors are already attached to charging cables, make sure that they're attached so that positive charger polarity will connect to positive battery terminal.

If connectors must be attached to charging cables, follow instructions supplied with connectors.

**CAUTION: Make sure connectors are securely attached to cables (good solder joint or well tightened set screws, whichever is applicable). Be certain that positive charger cable will connect to positive battery terminal. If necessary, trace cables into charger and use supplied connection diagram to determine polarity. The use of a DC voltmeter may show polarity. Improper connections will "blow" output fuse and may cause other damage.**

*Note: If this charger is equipped with certain optional features, the connector attaching procedure may be modified. Refer to OPTIONS chapter of this manual for details.*

## Pre-operation Checks

1. Inspect charger thoroughly for damage; loose screws, nuts, or electrical connections.

**WARNING: ELECTRICAL SHOCK HAZARD – Before inspecting or cleaning inside cabinet, turn OFF and remove fuses of disconnect switch (supplying AC power to charger), disconnect battery, and check for voltage on capacitors. Discharge through insulated screwdriver if there is any reading.**

2. Remove all special tags that are tied to charger. Keep tags with this manual for future reference. Leave all precautionary and instruction labels in place on charger. Carefully read and follow instructions on all tags and labels. Make sure all labels remain visible to anyone operating charger.
3. Make sure all charger cabinet panels are fastened in place, to assure proper flow of ventilating air through cabinet.

# OPERATION

## Preliminary

1. Make sure that charger is installed and grounded as instructed in this manual.
2. Make sure the charge control is set to the proper cell size via the charge control DIP switch cell selector.
3. Turn on main fused disconnect switch that supplies AC power to charger.
4. Maintain electrolyte level in batteries to be charged, as instructed by battery manufacturer. The volume of electrolyte will expand during the charge. Therefore, to avoid overfilling, do not add water until the battery has received at least an 80% charge. This will usually be reached at the time gassing starts.

## Normal or Daily Charge

**WARNING: DO NOT connect a battery to this charger if any LED is lit. Do not disconnect a battery from this charger while a charge is in progress; otherwise, arcing and burning of connector parts or a battery explosion may result. Batteries produce explosive gases. Keep sparks, flame and cigarettes away. Ventilate when charging in an enclosed area. Always shield eyes when working near batteries.**

1. Insure that battery size matches the charger. (Number of cells and ampere-hour capacity are within charger nameplate rating.)
2. Securely engage the battery and charger connectors.
3. After a 5 second delay (all LED's will be lit), the charger will turn on. The "Charge in Progress" LED will indicate charging current.
4. The "80% Charged" LED will light when the battery on charge reaches the 80% charged voltage.
5. The charger will automatically turn off and the "Charge Complete" LED will light when the charge has finished. The light will remain on until the battery is disconnected from the charger.

*NOTE: To disconnect battery from charger before charge is complete, first press the STOP key, then disconnect the battery from the charger.*

## Equalize or Weekend Charge

The AC500 features Auto Equalize every 5th charge cycle. Closing S1-9 disables the auto equalize feature; and an equalize charge request can be performed by pressing the "Equalize" push-button on the control front panel. When Auto Equalize is enabled (S1-9 is open), then the "Equalize" push-button cannot be used to request an equalize charge. The AC500 is shipped with auto equalize feature enabled. With auto equalize disabled, an equalize charge can be selected or de-selected for any charge cycle using the sequence below.

1. Insure that battery size matches the charger. (Number of cells and ampere-hour capacity are within charger nameplate rating.)
2. Securely engage the battery and charger connectors.
3. After a 5 second delay (all LED's will be lit), the charger will turn on. The "Charge in Progress" LED will indicate charging current.
4. Press the "Equalize" key. The "Equalize" LED will light solid. Press the key again to cancel the equalize charge.

*NOTE: The equalize charge cannot be cancelled once the battery reaches the equalize charging period. Press the STOP key to terminate the charge.*

5. The "80% Charged" LED will light when the battery on charge reaches the 80% charged voltage.
6. The battery reaches the normal termination point (pT/dV/dT or VT). However, the battery is charged another 3 hours. The "Equalize" LED will flash during this equalize period.
7. The charger will automatically turn off, and the "Charge Complete" and the "Equalize" LED will light when the equalized charge has finished. The LED's will remain on until the battery is disconnected from the charger.

**WARNING: DO NOT connect a battery to this charger if any LED is lit. Do not disconnect a battery from this charger while a charge is in progress; otherwise, arcing and burning of connector parts or a battery explosion may result. Batteries produce explosive gases. Keep sparks, flame and cigarettes away. Ventilate when charging in an enclosed area. Always shield eyes when working near batteries.**

## Manual Stop

1. To turn the charger off during any part of a charge cycle, press the STOP key. All four LEDs will flash.
2. To restart the charger, disconnect and reconnect the battery. A new charge cycle will begin.

## Battery Discrimination

The AC500 Control has the ability to reject batteries with cell sizes that do not match the cell size that the control is set up for (via DIP switch S1-1 through S1-6). If the battery connected to the charger has an average terminal voltage of greater than 2.30 volts/cell, the charger will not start and all 4 LEDs will flash, then the "Charge in Progress" LED will flash (high battery fault indication). If the battery voltage eventually falls below 2.30 volts/cell, the control will begin a normal charge sequence.

If the battery connected to the charger has an average terminal voltage of less than 1.75 volts/cell, the charger will not start and all 4 LEDs will flash, then the "80% Charged" LED will flash (low battery fault indication). If the battery voltage eventually rises above 1.75 volts/cell, the control will start a normal charge sequence. If the battery connected to the charger has a terminal voltage of less than 1.75 volts/cell and the operator wishes to start the charge regardless of this low battery voltage, the charge cycle will start if both the EQUALIZE and the STOP keys are held pushed in until all LEDs go out (approximately 5 seconds). Release the key at this time.

## Refresh Charge

In order to guarantee that a fully charged battery is always ready for use, a "Refresh" feature has been incorporated into the AC500 Control. If a battery is left connected to the charger for 72 hours after a "Charge Complete" has been reached, the AC500 will start a charge sequence. The running time of this "Refresh" charge will depend on the depth of self-discharge of the battery.

## Backup Timer Shutdown

A backup timer will shut down the charger and all 4 LEDs will flash then the "Charge Complete" LED will flash if the battery on charge does not reach the 80% voltage during the first 10 hours of charging.

Likewise, if the AC500 Control is set to terminate via the pT/dV/dT methodology (DIP switch S1-8 off) and the charger does not reach the termination point within 5 hours after reaching the 80% charged voltage, all 4 LEDs will flash then the "Charge Complete" LED will flash.

**WARNING: DO NOT connect a battery to this charger if any LED is lit. Do not disconnect a battery from this charger while a charge is in progress. Otherwise, arcing and burning of connector parts or a battery explosion may result. Batteries produce explosive gases. Keep sparks, flame, and cigarettes away. Ventilate when charging in an enclosed area. Always shield eyes when working near batteries.**

### **Battery Disconnect Shutdown**

If the battery is disconnected from the charger during a charge cycle, the charger will be shutdown. All LEDs will be off.

### **Low Current Shutdown**

If the charger output current falls below a predetermined level, a low current shutdown will occur. All 4 LEDs will flash, then the "Equalize" LED will flash.

### **AC POWER FAIL**

During an AC power failure, the AC500 Control stores key information about the charge cycle. The information is retained by powering some of the control's key components with a battery derived power supply. This causes the control to resume the charge where it left off when the AC power is returned, unaffected timers and equalize requests.

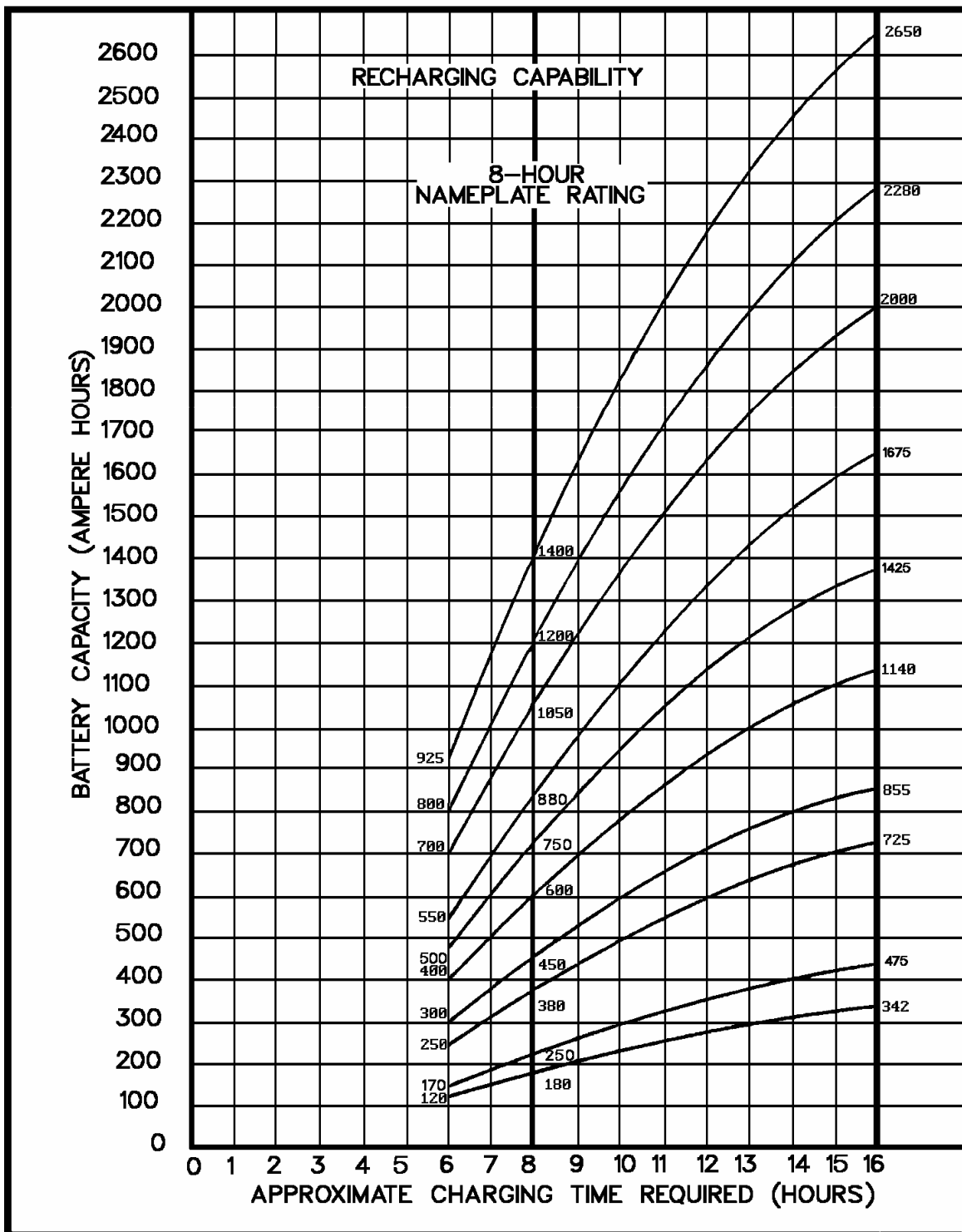

Figure 5-1

# MAINTENANCE

**WARNING: ELECTRICAL SHOCK HAZARD** — Before inspecting or cleaning inside cabinet, turn OFF and remove fuses of disconnect switch (supplying AC power to charger), disconnect battery, and check for voltage on capacitors. Discharge through insulated screwdriver if there is any reading.

## Inspection And Cleaning

For uninterrupted, satisfactory service from this charger, it's necessary to keep unit clean, dry, and well ventilated. At least every three months, or more often as necessary, wipe and blow out all dirt from unit's interior components, with clean, dry air of not over 25 psi (172 kPa) pressure. Use a hand bellows if compressed air isn't available.

Check and tighten all electrical connections as necessary to eliminate unnecessary losses and to avoid subsequent trouble from overheating or open circuits. Check for broken wiring or damaged insulation on wiring.

**WARNING: ELECTRICAL SHOCK HAZARD** — Failure to keep internal parts clean and dry may allow transformer (s) to short out, causing secondary circuits to carry dangerously high voltage.

Be sure to replace all charger cabinet panels after any servicing, to assure proper flow of cooling air through unit and to protect internal components.

**WARNING: ELECTRICAL SHOCK HAZARD** — All cabinet panels must be replaced to protect personnel from contact with hazardous voltages.

## Lubrication

None required.

## Charging Rate Adjustment

Although it is normally not required, the charging rate can be adjusted to accommodate unusually high or low AC power line voltages, unusually high or low ambient temperatures, or aged battery.

A rate adjustment is necessary if battery consumes more water than normal or if its specific gravity after a normal (daily) charge is not within 10 points of its gravity after a weekend (equalizing) charge.

**CAUTION: Before adjusting charging rate, make sure that bad connections or damage to charger isn't affecting charging process. Also make sure proper charging procedure has been followed (thoroughly read Operation chapter of this manual).**

**WARNING: ELECTRICAL SHOCK HAZARD** — Before adjusting charging rate, turn OFF and remove fuses of disconnect switch (supplying AC power to charger), disconnect battery, and check for voltage on capacitors. Discharge through insulated screwdriver if there is any reading.

	Yellow Jumper	Orange Lead	Charger Output
	8 to 9	to 12	Maximum Output ↑ Higher Output ↓ Lower Output Minimum Output
	8 to 10	to 12	
	8 to 9	to 11	
	8 to 10	to 11	
	8 to 9	to 10	
	8 to 9	to 8	
	8 to 10	to 9	
	8 to 11	to 10	
	8 to 11	to 9	
	8 to 12	to 10	
	8 to 12	to 9	
	8 to 12	to 9	

CONNECTION FOR MINIMUM OUTPUT SHOWN

**Table 6-1 Charging Rate Adjustment Table**

1. Locate charging rate adjustment label inside charger cabinet (same as Table 6-1). The factory set charging rate is indicated on this label by circles around terminal numbers to which YELLOW jumper and ORANGE lead were connected.
2. Locate YELLOW jumper and ORANGE lead on each transformer terminal block present in your unit (one transformer for single-phase, three for three-phase).
3. Mark present location of YELLOW jumper and ORANGE lead on charger rate adjustment label and on Table 6-1 if different from that marked by factory.
4. Reconnect YELLOW jumper and ORANGE lead to the terminals giving the desired change of charging rate, as shown in Table 6-1.

**CAUTION: Do not change connections more than one step before observing effect on charging rate. On fully charged battery (approx. 1.270 to 1.290 specific gravity), rate should not exceed 22% of "MAX AMPS" on charger nameplate. On fully discharged battery (approx. 1.140 specific gravity), rate should not exceed 110% of "MAX AMPS".**

**On three-phase chargers, all transformer terminal blocks must be identically connected.**

## Fuse Replacement

The silicon diodes in this charger are protected by a "fast-clearing" type fuse.

**CAUTION: The use of any other type fuse besides the "fast-clearing" type may cause damage to silicon diodes.**

## Silicon Diode Testing

**WARNING: ELECTRICAL SHOCK HAZARD — Before checking electrical components, turn OFF and remove fuses of disconnect switch (supplying AC power to charger), disconnect battery, and check for voltage on capacitors. Discharge through insulated screwdriver if there is any reading.**

1. Disconnect one diode lead to isolate diode on each transformer from electrical circuitry.
2. Use a good quality ohmmeter (preferably one having a mid-scale value of approximately 50 ohms) to measure resistance values.
3. Zero ohmmeter on R x 1 scale.
4. Record indicated resistance while placing either ohmmeter lead on threaded end of diode and other ohmmeter lead on diode lead.



5. Reverse ohmmeter leads on diode and record indicated resistance.
6. Consider diode good if one resistance reading is infinitely (or very) high and the other is extremely low.

*NOTE: An acceptable low resistance value or range of values can't be given because of different readings from different ohmmeters, and differences in diodes of the same rating.*

## Capacitor Testing

1. Heed WARNING in Silicon Diode Testing section.

2. Disconnect capacitor and connect leads of ohmmeter (set to highest scale) to capacitor terminals.

3. If capacitor is good, pointer will deflect, indicating capacitor is being charged, followed by a deflection in the opposite direction indicating partial discharge.

If there is no deflection, capacitor is "open" and must be replaced. Also, if meter needle moves and stops at one value, replace capacitor.

Replacement capacitors must be ordered from factory. When ordering, supply serial number of charger and microfarad (MFD) or ( $\mu\text{F}$ ) value printed on capacitor.

## Troubleshooting

**DANGER: ELECTRICAL SHOCK HAZARD** — Before checking electrical components, turn OFF and remove fuses or disconnect switch (supplying AC power to charger), disconnect battery, and check for voltage on capacitors. Discharge through insulated screwdriver if there is any reading.

**CAUTION: HIGH VOLTAGE FROM TEST EQUIPMENT** can damage silicon diodes and other parts. Short silicon diodes with extremely short leads, or disconnect, before applying voltage from a "megger" or other high voltage test equipment.

The following chart contains information which can be used to diagnose and correct unsatisfactory operation or failure of various components of the unit. Each malfunction is followed by a suggested checking or inspection procedure. Refer to Connection/Schematic Diagram in the Diagrams chapter included in this manual.

### Troubleshooting Guide

#### **No charging current (Ammeter reads zero)**

Check line voltage.

*Close fused disconnect switch or repair open circuit.*

Check for proper line voltage.

*Refer to Line Voltage Changeover instructions in Installation chapter.*

Check for blown fuses.

*Replace blown fuses. See Table 4-1 for proper fuse sizes.*

Check for internal short circuit (diode, winding, wiring).

*Repair short circuit, or replace faulty component.*

Check for "open" battery circuit.

*Clean and tighten connections, especially battery cable connections.*

Check Charge Control.

*If control has electromechanical timer, check contacts. If they are not closing, repair or replace timer.*

*Connect a jumper from the red-white lead of Control Transformer T1 to the red lead of Contactor K1 coil. If charger starts and ammeter shows charging current when a battery is connected, check further for faulty printed circuit card on control and replace as necessary.*

Check output circuit fuses. If fuse has blown, check for problem causing fuse to blow.

a. *Reverse battery connections, if polarity is wrong.*

b. *Determine whether a diode is shorted. Refer to Silicon Diode Testing in Maintenance chapter.*

**Low charging current at beginning of cycle (battery fully discharged)**

Check for failed capacitor (s) (one or more).

*Replace capacitor if can is ruptured or fails test. Refer to Capacitor Testing in Maintenance chapter.*

Check charging rate for "too low" adjustment.

*Refer to Charging Rate Adjustment in Maintenance chapter.*

Check line voltage for connection to proper input voltage.

*Refer to Line Voltage Changeover instructions in Installation chapter.*

Check battery for one or more defective cells.

**Less than rated output on fully discharged battery (approximately 1/2 rated output) (3-phase chargers only)**

Check input fuses (one probably blown). Check for either a shorted transformer, or wiring short circuit.

*Replace as necessary.*

**High charging current at beginning of cycle (battery overcharged)**

Check charging current for "too high" adjustment.

*Refer to Charging Rate Adjustment in Maintenance chapter.*

**Charger does not shut OFF automatically or start automatically**

Check Charge Control.

1. If equipped with electromechanical timer

*A. Check timer switch contacts. If they are "welded" together and show continuity when timer is off, replace timer.*

*B. Check to see if timer control motor is running.*

*C. Replace timer if there is not continuity of timer motor field. Check AC power supply to motor.*

2. If charger does not start automatically, check for 24 volts AC between the red-white lead and the red-black lead of control transformer T1. If 24V AC is present, connect a jumper from the red-white lead of control transformer T1 to the red lead of contactor K1 coil. If charger starts, check further for faulty printed circuit card on control and replace as necessary.

3. If charger does not stop automatically when equipped with voltage time or dV/dT controls, check to be sure charging voltage rises above 2.37 volts/cell during the cycle. If not, see low charging current or less than rated output above. If battery on-charge voltage rises above 2.37 volts/cell during the cycle, check for defective control printed circuit card.

**DANGER: ELECTRICAL SHOCK HAZARD** — Before checking electrical components, turn OFF and remove fuses of disconnect switch (supply AC power to charger), disconnect battery, and check for voltage on capacitors. Discharge through insulated screwdriver if there is any reading.

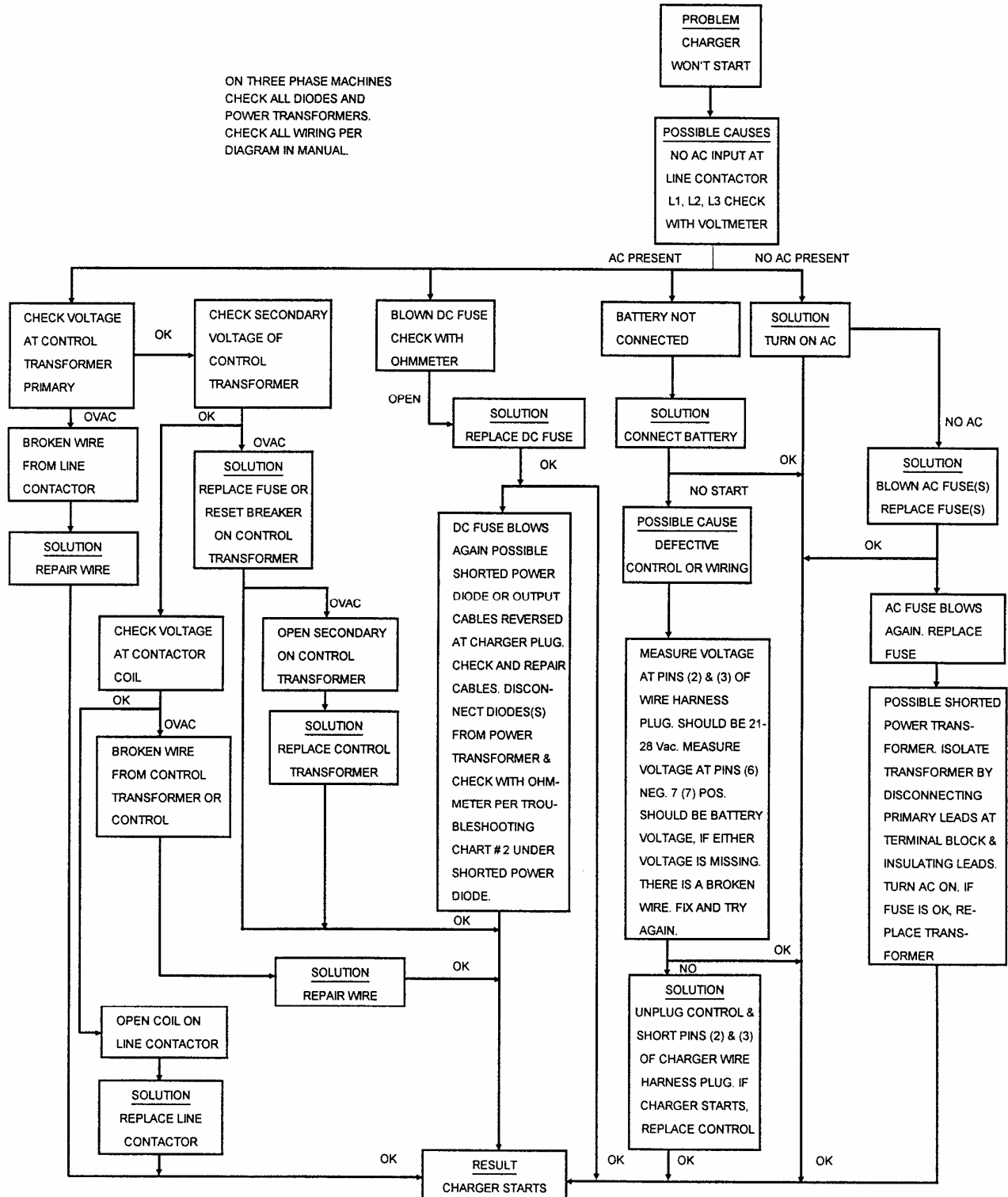

**DANGER: ELECTRICAL SHOCK HAZARD** — Before checking electrical components, turn OFF and remove fuses of disconnect switch (supply AC power to charger), disconnect battery, and check for voltage on capacitors. Discharge through insulated screwdriver if there is any reading.

ON THREE PHASE MACHINES  
 CHECK ALL DIODES AND AC  
 CAPACITORS. CHECK ALL  
 WIRING PER DIAGRAM IN  
 MANUAL

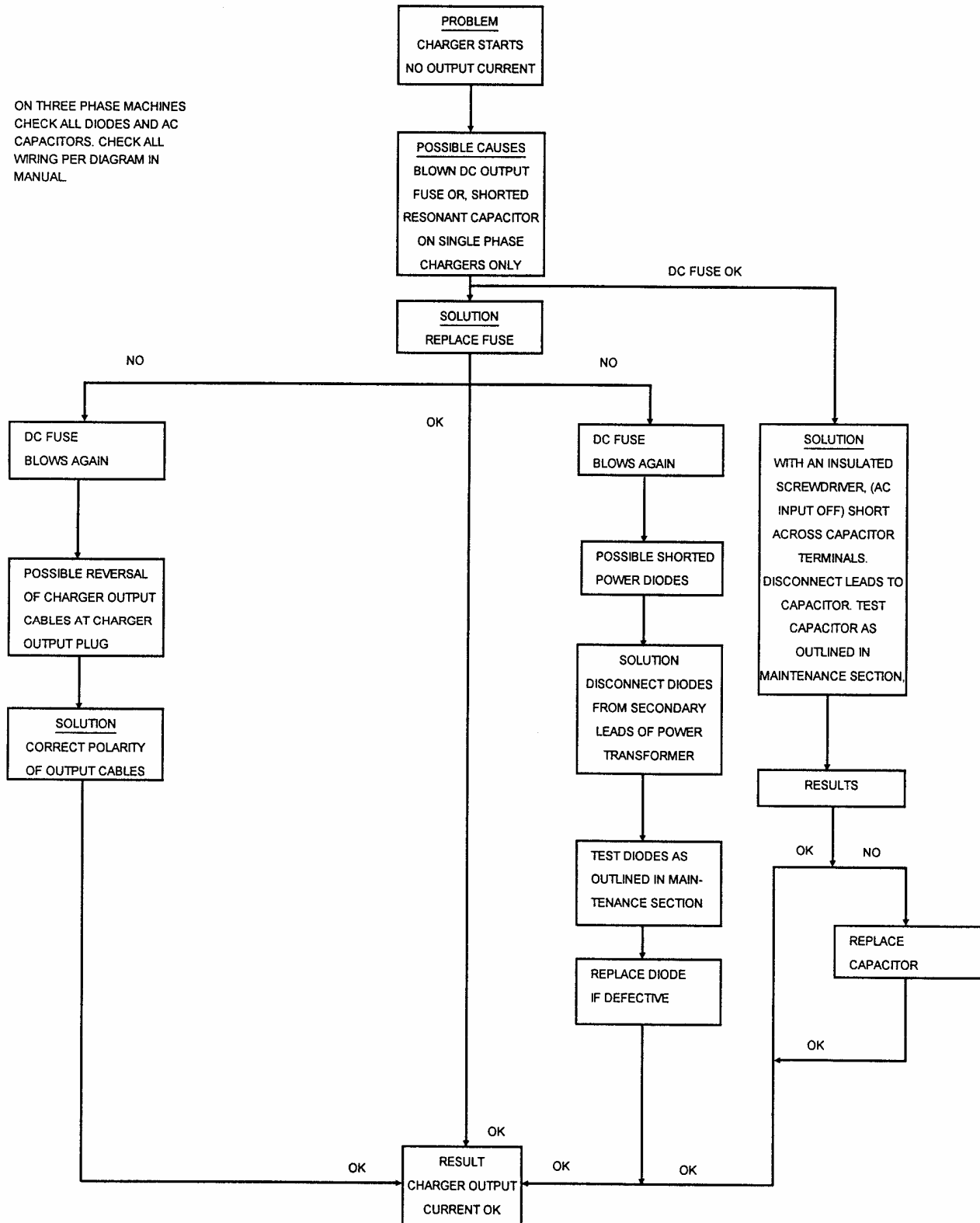

**DANGER: ELECTRICAL SHOCK HAZARD** — Before checking electrical components, turn OFF and remove fuses of disconnect switch (supply AC power to charger), disconnect battery, and check for voltage on capacitors. Discharge through insulated screwdriver if there is any reading.

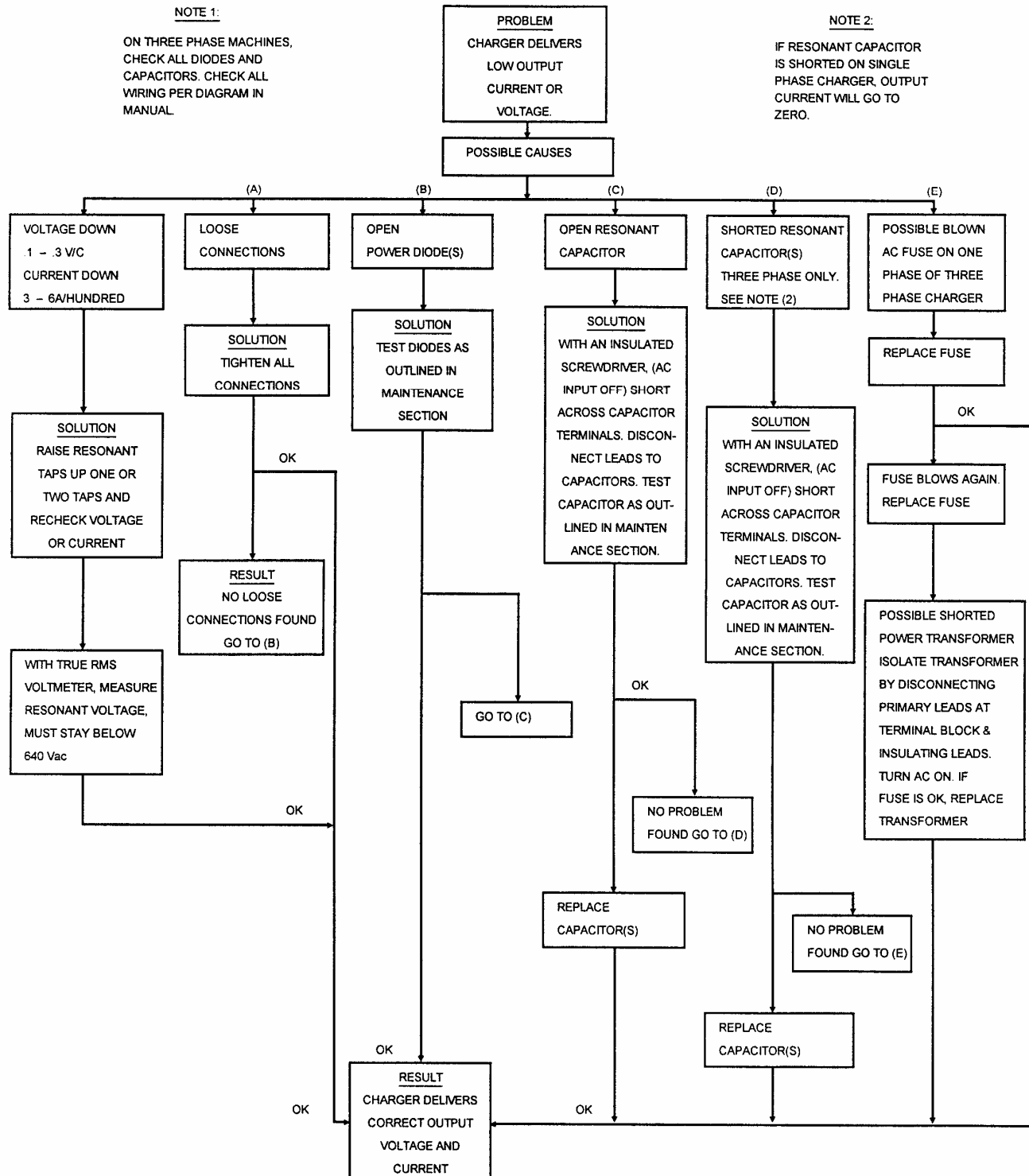

# OPTIONS

The options listed in the following table of contents are those most commonly available. Special options not listed here will be covered by enclosed “addendum” sheets.

OPTION NUMBER	OPTION DESCRIPTION	PAGE
002	Parallel Charging.....	7-1
003	Series Charging.....	7-1
101	Remote Charge Control and Ammeter.....	7-2
500	Fused Disconnect Switch and 24V Control Circuit.....	7-2

## Parallel Charging – Option 002

This option provides cables allowing two batteries to be charged at the same time (batteries connected in parallel to charger).

To prevent premature charger turn on, this option requires the use of a battery connector with auxiliary contacts (Anderson “SBX” or equivalent). The same type connector must be specified on the battery and vehicle. The connector on the battery must have the auxiliary contacts jumpered together.

*NOTE: The safety interlock circuit is protected by an in-line 1 Amp AGC Fuse inside the battery charger.*

When charging two batteries, each must be of the same voltage (or number of cells). The total rated ampere-hour capacity of both batteries plus the voltage (number of cells of only one of the batteries) must be within the range of the charger. Refer to charger nameplate for ratings. For example: two 12-volt (6 cell), 225 ampere-hour batteries would make a 12-volt (6 cell), 450 ampere-hour load.

Operate this charger as instructed in Operation chapter of this manual except that batteries are to be connected as shown in Figure 7-1, plus the total ampere-hour capacity must be used to calculate charging time.

**CAUTION: Make sure all connections are made positive to positive and negative to negative as shown.**

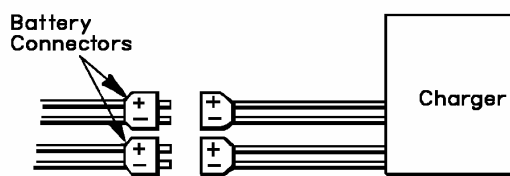

Figure 7-1 Parallel Charging Connections

## Series Charging – Option 003

This option provides a cable allowing two batteries to be charged at the same time (batteries connected in series to charger).

**CAUTION: With the batteries required to be connected in series, this charger cannot be used to charge one battery only.**

Both batteries must be of the same ampere-hour rating. The total rated voltage (or number of cells) of both batteries (add the two), plus the ampere-hour capacity of only one battery, must be within the charger nameplate range ratings. For example: two 12-volt (6-cell), 450 ampere-hour batteries would make a 24-volt (12-cell), 450 ampere-hour load.

For series charging, both batteries must be at identical depths of discharge (DOD); ie, they are used in series in the vehicle. A mismatch in DOD of the two batteries will result in severe overcharge of the lightly discharged battery and severe undercharge of a deeply, discharged battery.

Operate this charger as instructed in Operation chapter of this manual, except that charger must be connected to both batteries instead of just one. Refer to Figure 7-2.

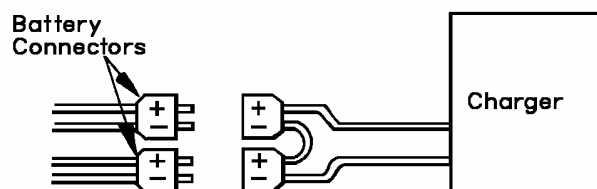

Figure 7-2 Series Charging Connections

**CAUTION:** Make sure all connections are made positive to positive and negative to negative as shown.

## Remote Charge Control – Option 101

This option provides a separate remote control box containing charger's Charge Control.

This remote control box must be connected to charger as instructed on label provided with remote charge control. Closely observe wire color coding.

Operate this charger as instructed in Operation chapter of this manual and as instructed under any applicable option descriptions.

## Fused Disconnect Switch – Option 500 (Refer to Figure 7-3)

This option is provided to meet certain “JIC” requirements. The switch must be in the open (OFF) position to disconnect all AC power into charger and to allow front door to be opened. With switch in open position, door can be opened by turning slotted latch screw to the left.

Disconnect switch is for *emergency* or *service use* only.

Charge cycle should continue until automatically shut off. If cycle must be interrupted, turn timer to “OFF” or push “STOP” button.

A control circuit operating on 24 volts is also provided to help assure operator safety.

Fused Disconnect Switch  
(Shown in ON Position)

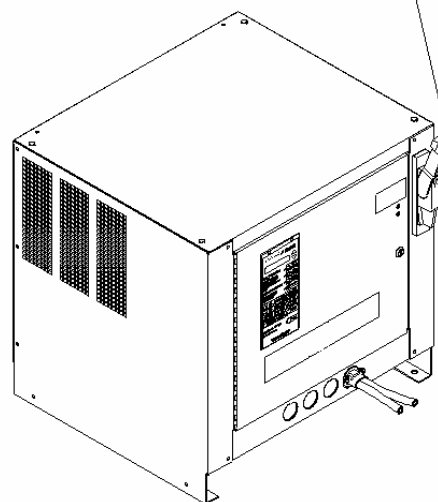

Figure 7-3 Fused Disconnect Switch



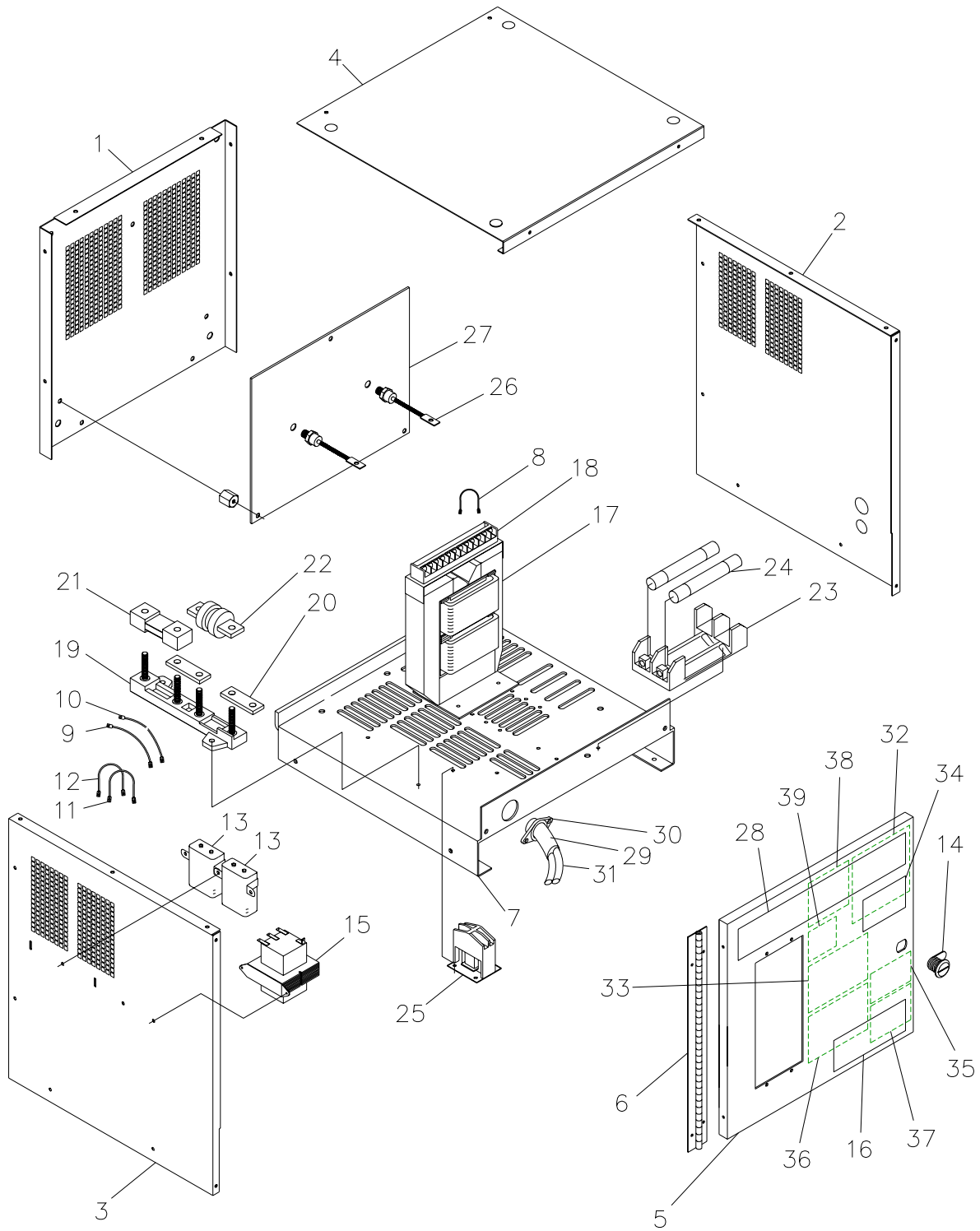

Figure 8-1 "A" Case

“A” CASE PARTS LIST

<u>ITEM NO.</u>	<u>PART NO.</u>	<u>DESCRIPTION</u>
1	197157	Panel, Rear
2	197159	Panel, Side, Right
3	197158	Panel, Side, Left
4	197163	Top
5	197164	Door
6	197165	Hinge
7	197324	Base
8	357205-357	Lead, Yellow (1 Req'd)
9	357205-127	Lead, Orange (1 Req'd)
10	357205-128	Lead, White (1 Req'd)
11	357205-060	Jumper, Orange (2 Req'd)
12	357205-061	Jumper, White (2 Req'd)
13	See Table	Capacitor, Transformer
14	194530	Latch, Door
15	See Table	Transformer, Control
16	196036	Label, Prestolite
17	See Table	Transformer, Power
18	Contact Factory	Terminal Block
19	193114	Insulator, Fuse & Shunt
20	392458	Bus Bar
21	See Table	Shunt, Meter
22	See Table	Fuse, Output
23	See Table	Block, Input Fuse
24	See Table	Fuse, Input
25	See Table	Contactactor, AC Input
26	402832-003	Diode, Silicon (2 Req'd)
27	197024	Heat Sink
28	406338	Label, Identification
29	378234-013	Cover, Outer Neoprene
30	W10085-005	Connector, Strain Relief
31	See Table	Cable, DC Output
32	See Table	Label, AC Input
33	194335	Label, Danger, AC Volts & Fuse
34	404099	Label, Danger
35	191892	Label, Rain Exposure
36	402717	Label, Charging Rate
37	406434	Label, Input Warning
38	195531	Label, DC Output Fuse
39	406593	Label, AC Input Fuse
40	197290	Harness, Wire (For Modular Control)

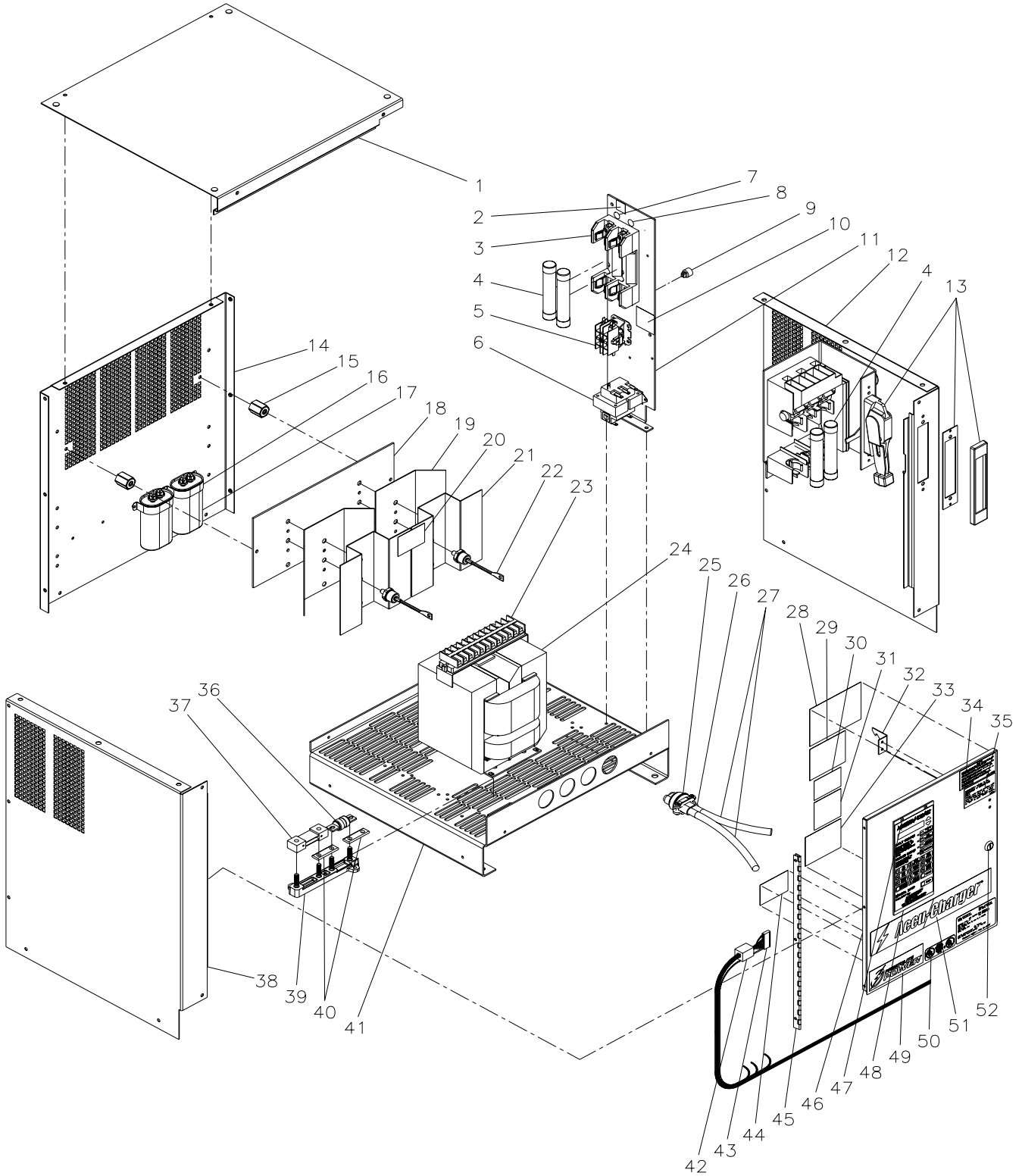

Figure 8-2 "B" Case

**“B” CASE PARTS LIST**

Item No.	Part No.	Description
1	194457	Panel, Top
2	405548	Label, Frame Ground
3	Table 8-3	Block, Fuse, Input
4	Table 8-3	Fuse, Input
5	Table 8-3	Contact, Line
6	Table 8-4	Transformer, Control
7	400092	Label, L1
8	400096	Label, L2
9	194827-1	Grommet, Mounting
10	406593	Label, Supply Connections
11	194447	Panel, Interior
12	Table 8-5	Panel, Side, Right
13	Table 8-5	Switch, Disconnect
14	194454	Panel, Rear
15	404033	Insulator, Heat Sink
16	TRY174-3	Bracket, Mtg., Capacitor
17	Table 8-6	Capacitor, Transformer
18	191191	Heat Sink, Flat
19	191192	Heat Sink, Fin, 45
20	406518	Label, Warning, Heat Sink
21	191193	Heat Sink, Fin, 90
22	Table 8-1	Diode, Silicon
23	Table 8-3	Block, Terminal, Transformer
24	Call Factory	Transformer
25	W10080-5	Connector, Strain Relief
26	378234-13	Cover, Neoprene
27	Table 8-2	Cable, Output Charging
28	Table 8-4	Label, AC Input
29	194335	Label, Danger, Input Volt. & Fuse
30	191892	Label, Warning, Rain Exposure
31	406434	Label, Warning, Sparks
32	Table 8-5	Latch, Door, Disconnect
33	402717	Label, Charging Rate
34	404099	Label, Danger
35	Table 8-5	Label, Disconnect Switch
36	Table 8-2	Fuse, Output
37	Table 8-2	Shunt, Current
38	194455	Panel, Side, Left
39	193114	Insulator, Shunt / Fuse
40	392458	Bus Bar
41	194453	Base, Charger
42	192266-1	Suppressor, Harness
43	196096	Harness, Interior Panel
44	405026	Label, Fuse, DC Output
45	194377	Hinge, Door
46	194458	Door, Hinged
47	193101-1	Rivet, Snap
48	Call Factory	Control, Charger
49	196036	Label, Prestolite Power
50	404079	Label, UL and CUL
51	Table 8-7	Label, Charger
52	194530	Latch, Door

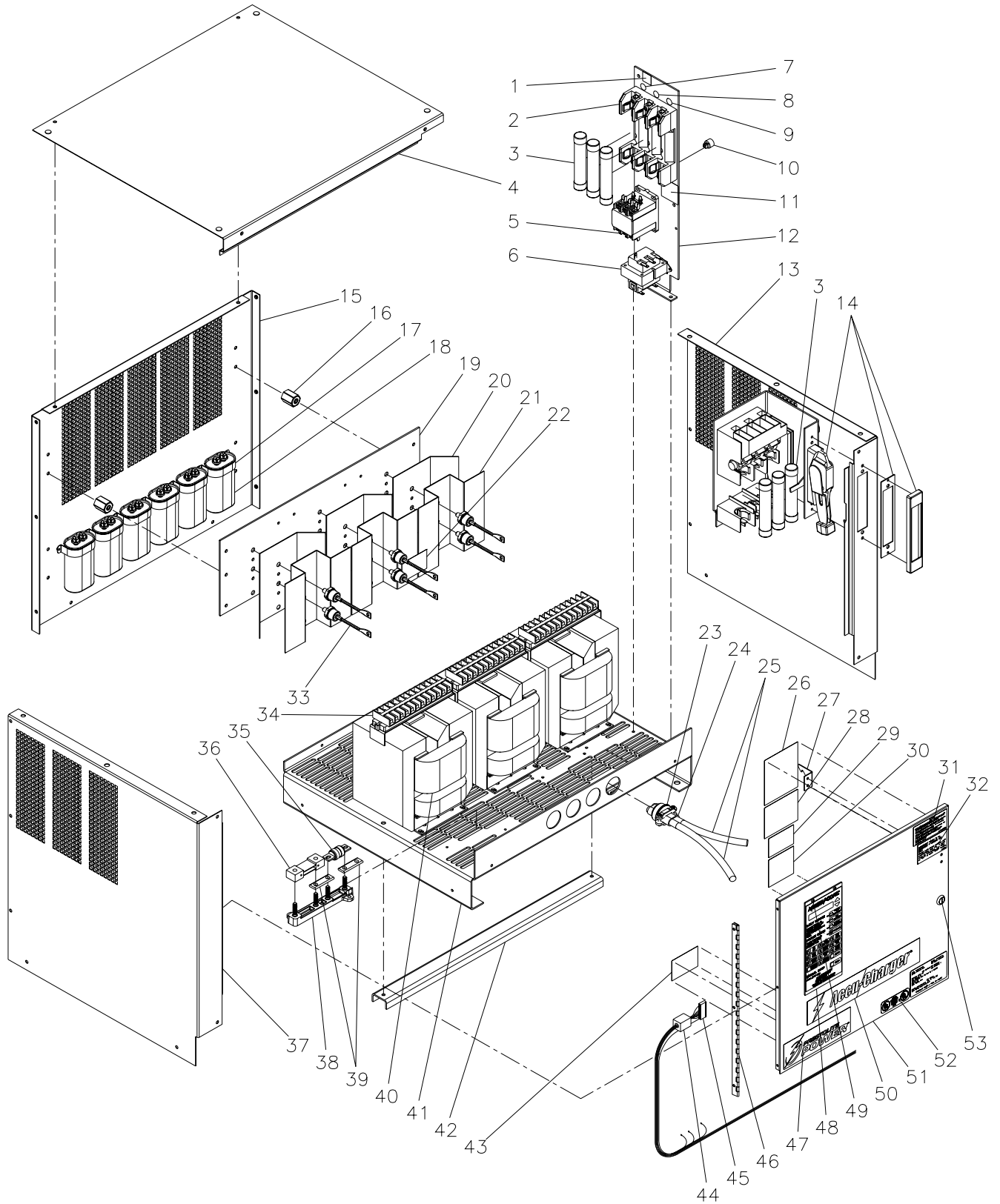

Figure 8-3 "C" Case

“C” CASE PARTS LIST

Item No.	Part No.	Description
1	405548	Label, Frame Ground
2	Table 8-3	Block, Fuse, Input
3	Table 8-3	Fuse, Input
4	194376	Panel, Top
5	Table 8-3	Contact, Line
6	Table 8-4	Transformer, Control
7	400092	Label, L1
8	400096	Label, L2
9	400097	Label, L3
10	194827-1	Grommet, Mounting
11	406593	Label, Supply Connections
12	194447	Panel, Interior
13	Table 8-5	Panel, Side, Right
14	Table 8-5	Switch, Disconnect
15	194373	Panel, Rear (See Note 1)
16	404033	Insulator, Heat Sink
17	TRY174-3	Bracket, Mtg., Capacitor
18	Table 8-6	Capacitor, Transformer
19	392456	Heat Sink, Flat
20	191192	Heat Sink, Fin, 45
21	191193	Heat Sink, Fin, 90
22	406518	Label, Warning, Heat Sink
23	W10080-5	Connector, Strain Relief
24	378234-13	Cover, Neoprene
25	Table 8-2	Cable, Output Charging
26	Table 8-4	Label, AC Input
27	Table 8-5	Latch, Door, Disconnect
28	194335	Label, Danger, Input Volt. & Fuse
29	191892	Label, Warning, Rain Exposure
30	406434	Label, Warning, Sparks
31	404099	Label, Danger
32	Table 8-5	Label, Disconnect Switch
33	Table 8-1	Diode, Silicon
34	Table 8-3	Block, Terminal, Transformer
35	Table 8-2	Fuse, Output
36	Table 8-2	Shunt, Current
37	194374	Panel, Side, Left (See Note 2)
38	193114	Insulator, Shunt / Fuse
39	392458	Bus Bar
40	Call Factory	Transformer
41	194372	Base, Charger
42	194371	Support, Transformer
43	405026	Label, Fuse, DC Output
44	192266-1	Suppressor, Harness
45	196096	Harness, Interior Panel
46	194377	Hinge, Door
47	196038	Label, Prestolite Power
48	Call Factory	Control, Charger
49	193101-1	Rivet, Snap
50	Table 8-7	Label, Charger
51	194378	Door, Hinged
52	404079	Label, UL and CUL
53	194530	Latch, Door

Note 1: Item 15 (Rear Panel), for chargers with weather-resistant enclosure (Opt. 013), is 196546.

Note 2: Item 37 (Left Side Panel), for chargers with weather-resistant enclosure (Opt. 013), is 1965561.

<u>NO. CELLS</u> from charger nameplate	<b>DIODE PART NUMBER</b>		
	1-Phase Charger	3-Phase Charger having <u>DC OUTPUT MAX. AMPS</u> nameplate rating less than 150A	3-Phase Charger having <u>DC OUTPUT MAX. AMPS</u> nameplate rating equal to or greater than 150A
6-24	402832-3	193143-1	402832-3
25-36	402832-4	193143-1	402832-4
37-48	402832-6	193143-2	402832-6

Table 8-1 Power Diodes

<u>DC OUTPUT</u> <u>MAX. AMPS</u> Nameplate Rating	DC Output Fuse		Shunt		DC Output Cables	
	Amp Rating	Part No.	Amp Rating	Part No.	Size	Part No.
0 – 50	70 Amp	Y1890-1	100 Amp	193125-1	#4	396263-94
51 – 76	100 Amp	Y1890-3	100 Amp	193125-1	#4	396263-94
76 – 80	100 Amp	Y1890-3	100 Amp	193125-1	#2	396263-80
81 – 120	150 Amp	Y1890-4	200 Amp	193125-2	#2	396263-80
121 – 150	200 Amp	Y1890-5	200 Amp	193125-2	1/0	396263-81
151 – 176	250 Amp	Y1890-6	200 Amp	193125-2	1/0	396263-81
177 – 210	300 Amp	Y1890-7	400 Amp	193125-3	2/0	396263-82
211 – 240	350 Amp	Y1890-8	400 Amp	193125-3	2/0	396263-82
241 – 280	350 Amp	Y1890-8	400 Amp	193125-3	3/0	396263-95
281 – 320	350 Amp	Y1890-8	400 Amp	193125-3	4/0	396263-93

Table 8-2 DC Output Components

AC INPUT MAX. AMPS Nameplate Rating	AC Input Fuse		Input Fuse Block Part No. *			Transformer Terminal Block Part No. *		Line Contactor Part No. *		
	Amp Rating	250 VAC ** Part No.	600 VAC ** Part No.	1-Phase 250 VAC ** Part No.	1-Phase 600 VAC ** Part No.	3-Phase 600 VAC ** Part No.	1-Phase Part No.	3-Phase Part No.	1-Phase Part No.	3-Phase Part No.
0 - 12	15	W10085-5	W10386-5	405357-1	406207-1	404605-4	402520	402520	406240-1	406243-1
12.1 - 16	20	W10085-6	W10386-6	405357-1	406207-1	404605-4	402520	402520	406240-1	406243-1
16.1 - 20	25	W10085-7	W10386-7	405357-1	406207-1	404605-4	402520	402520	406240-1	406243-1
20.1 - 24	30	W10085-8	W10386-8	405357-1	406207-1	404605-4	402520	402520	406240-1	406243-1
24.1 - 28	35	W10085-9	W10386-9	405752-1	406207-2	404605-5	408174	402520	406240-1	406243-1
28.1 - 32	40	W10085-10	W10386-10	405752-1	406207-2	404605-5	408174	402520	406241-1	406243-1
32.1 - 36	45	W10085-11	W10386-11	405752-1	406207-2	404605-5	408174	402520	406241-1	406243-1
36.1 - 40	50	W10085-12	W10386-12	405752-1	406207-2	404605-5	408174	402520	406241-1	406243-1
40.1 - 48	60	W10085-13	W10386-13	405752-1	406207-2	404605-5	N/A	408174	406244-1	406244-1

\* Part Number is determined by the highest AC INPUT MAX. AMPS nameplate rating.  
 \*\* The highest AC INPUT VOLTS nameplate rating is equal to or less than this voltage.

Table 8-3 AC Input Components

Charger AC INPUT VOLTS Nameplate Rating	Output Control Transformer 24V AC Part No.	AC Input Label Part No.
120/208/240	406247-1	406465
208/240/480	406247-2	406461
220/380/415	406247-3	406928
240/480/575	406247-4	406365

Table 8-4 Control Transformer



Disconnect Switch (Option 500)	Disconnect Switch Part No.	Door Latch (for Disc. Sw.) Part No.	Label, Disc. Sw. Part No.	"B" Case Right Side Panel Part No.	"C" Case Right Side Panel Part No.
Without Disc. Sw.	None	None	None	194565	194521 196562 (w/Opt 013)
With Disc. Sw. (up to 30A Input Fuses)	403956-1	194379	407250	194456	194375 196564 (w/Opt 013)
With Disc. Sw. (35-60A Input Fuses)	403956-2	194379	407250	194456	194375 196564 (w/Opt 013)

Table 8-5 Disconnect Switch

Part Number	MFD Rating marked on capacitor (Replace with same exact rating)
TRY-154-1	3
TRY-154-2	6
TRY-154-3	8
TRY-154-4	12
TRY-154-6	24

Table 8-6 Capacitor

Label Description	Part Number
Accu-Charger	406338
Battery-Mate 100	196665
Battery-Mate 80	196664
Battery-Mate 60	196663

Table 8-7 Charger Label

---

# DIAGRAMS

Model no. Information		DIAGRAM OUTPUT SCHEMATIC	OUTLINE DIMENSION
CASE SIZE	LAST 2 DIGITS		
A	—	197325	197203
B	—	396513	194449
C3	—	396520	194449
C1	—	196612	194449
C1	—	193536	194449

See model number description inside front cover.







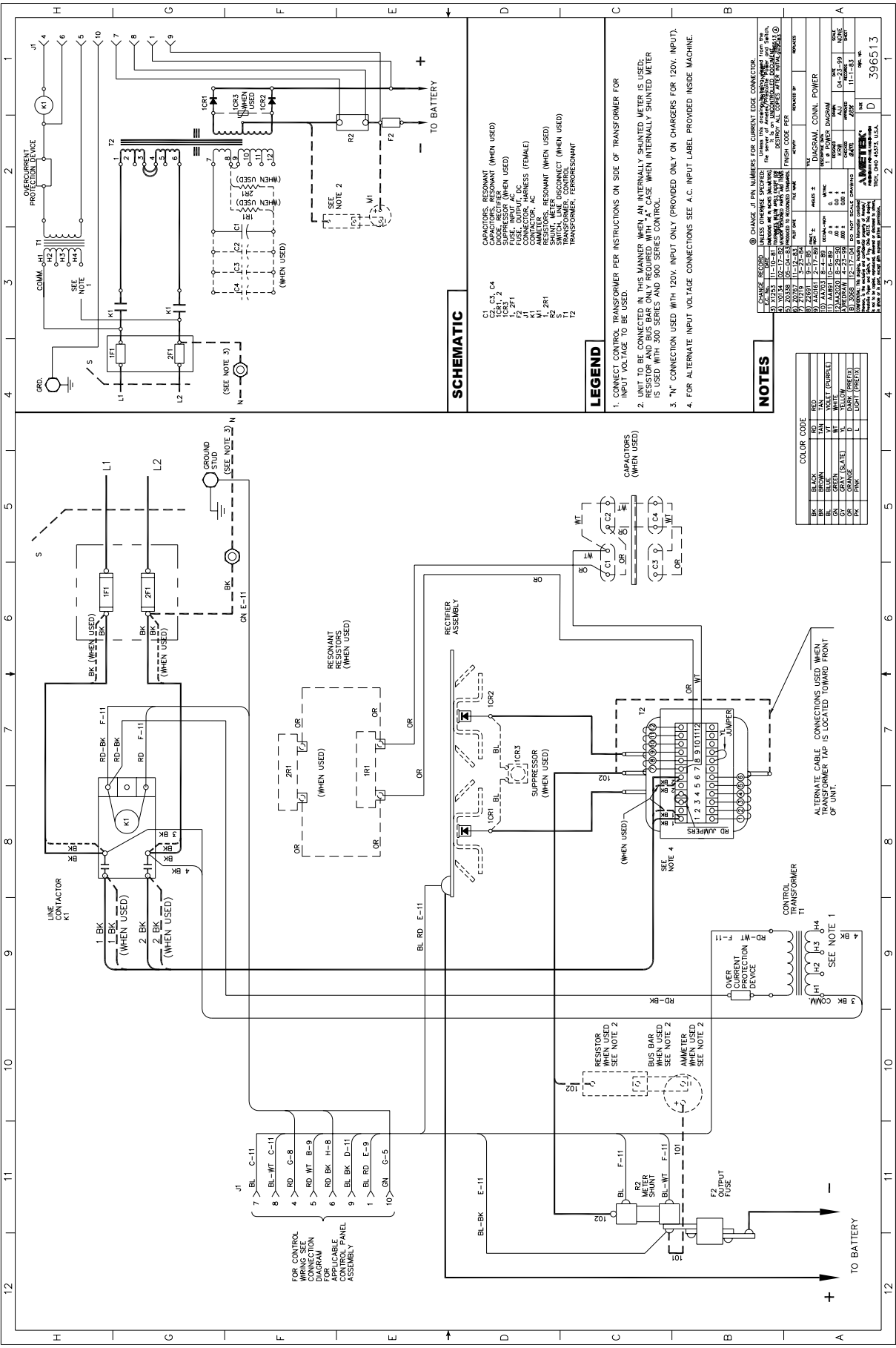

**SCHEMATIC**

- C1, C2, C3, C4 CAPACITORS, RESONANT (WHEN USED)
- ICR1 SUPPRESSOR (WHEN USED)
- F1 FUSE, INPUT AC (WHEN USED)
- J1 CONNECTOR, HARNESS (FEMALE)
- K1 AMMETER, AC (WHEN USED)
- K2 SHUNT, METER (WHEN USED)
- T1 TRANSFORMER, FERRORESONANT (WHEN USED)
- T2 TRANSFORMER, FERRORESONANT (WHEN USED)

**LEGEND**

1. CONNECT CONTROL TRANSFORMER PER INSTRUCTIONS ON SIDE OF TRANSFORMER FOR INPUT VOLTAGE TO BE USED.
2. UNIT TO BE CONNECTED IN THIS MANNER WHEN AN INTERNALLY SHUNTED METER IS USED. RESISTOR AND BUS BAR ONLY REQUIRED WITH "A" CASE. WHEN INTERNALLY SHUNTED METER IS USED WITH 300 SERIES AND 900 SERIES CONTROL.
3. "N" CONNECTION USED WITH 120V. INPUT ONLY (PROVIDED ONLY ON CHARGERS FOR 120V. INPUT).
4. FOR ALTERNATE INPUT VOLTAGE CONNECTIONS SEE A.C. INPUT LABEL PROVIDED INSIDE MACHINE.

**NOTES**

① CHANGE J1 PIN NUMBERS FOR CURRENT EDGE CONNECTOR.

UNLESS OTHERWISE SPECIFIED: (A) Values of components are in U.S. units. (B) Values in parentheses are for alternate units. (C) Values in parentheses are for alternate units. (D) Values in parentheses are for alternate units. (E) Values in parentheses are for alternate units. (F) Values in parentheses are for alternate units. (G) Values in parentheses are for alternate units. (H) Values in parentheses are for alternate units. (I) Values in parentheses are for alternate units. (J) Values in parentheses are for alternate units. (K) Values in parentheses are for alternate units. (L) Values in parentheses are for alternate units. (M) Values in parentheses are for alternate units. (N) Values in parentheses are for alternate units. (O) Values in parentheses are for alternate units. (P) Values in parentheses are for alternate units. (Q) Values in parentheses are for alternate units. (R) Values in parentheses are for alternate units. (S) Values in parentheses are for alternate units. (T) Values in parentheses are for alternate units. (U) Values in parentheses are for alternate units. (V) Values in parentheses are for alternate units. (W) Values in parentheses are for alternate units. (X) Values in parentheses are for alternate units. (Y) Values in parentheses are for alternate units. (Z) Values in parentheses are for alternate units.

UNIT	DIAGRAM	CONNECTION	WIRE COLOR	TERMINAL
1	104-01-01	1	RED	1
1	104-01-01	2	RED	2
1	104-01-01	3	RED	3
1	104-01-01	4	RED	4
1	104-01-01	5	RED	5
1	104-01-01	6	RED	6
1	104-01-01	7	RED	7
1	104-01-01	8	RED	8
1	104-01-01	9	RED	9
1	104-01-01	10	RED	10
1	104-01-01	11	RED	11
1	104-01-01	12	RED	12

COLOR	CODE
BLACK	RD
BROWN	BR
GREEN	GR
RED	RD
WHITE	WT
YELLOW	YL
ORANGE	OR
PINK	PK
GRAY	GRY
BLUE	BL
GREEN	GR
RED	RD
WHITE	WT
YELLOW	YL
ORANGE	OR
PINK	PK
GRAY	GRY
BLUE	BL

ALTERNATE CABLE CONNECTIONS USED WHEN TRANSFORMER TAP IS LOCATED TOWARD FRONT OF UNIT.

FOR CONTROL WIRING SEE CONNECTION DIAGRAM FOR APPLICABLE PANEL ASSEMBLY.

396513

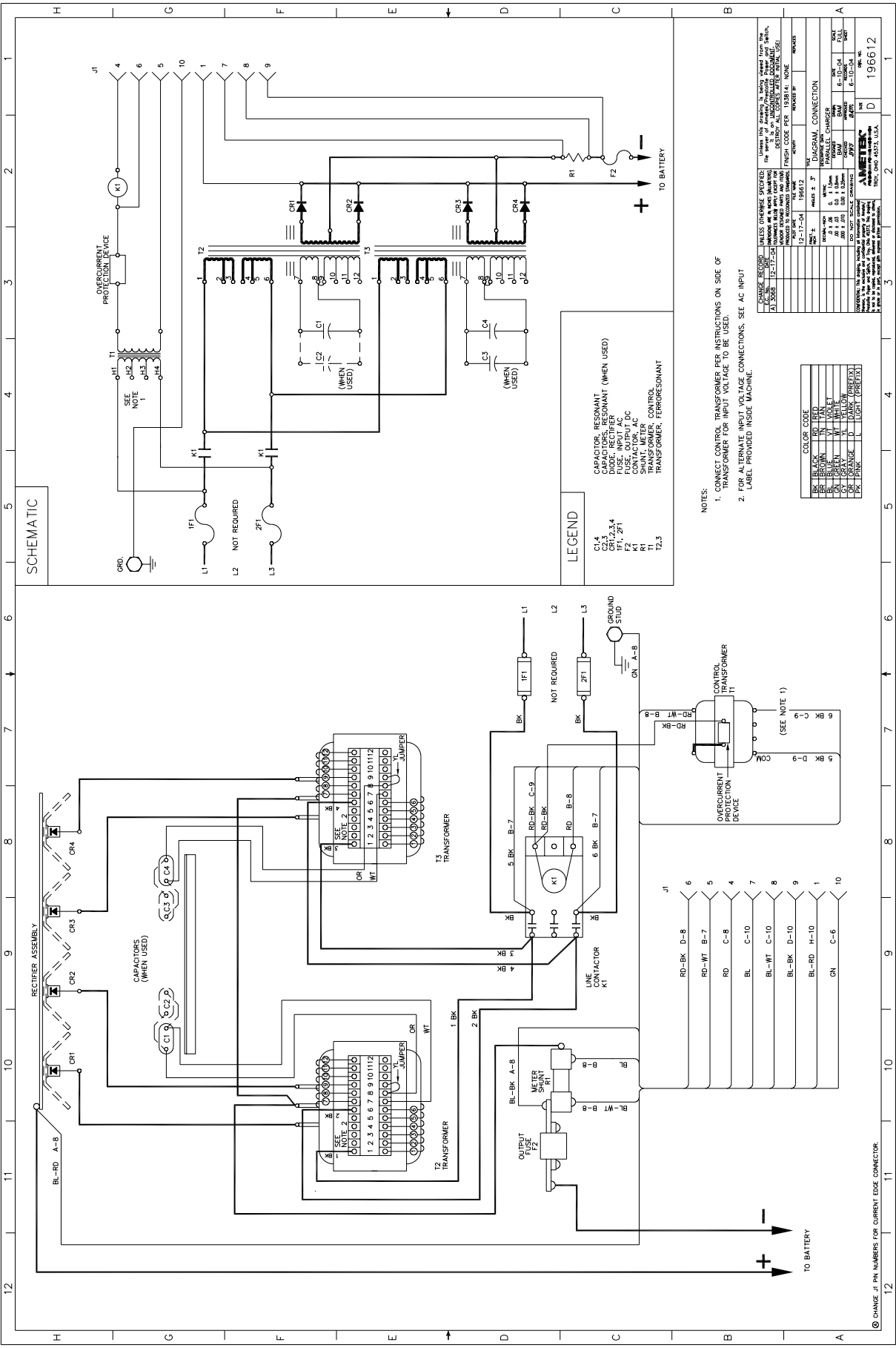

CHANGE REQUIRED UNLESS OTHERWISE SPECIFIED: (In the event of a change in the design of the machine, the user should refer to the latest issue of the instruction manual for the correct wiring diagram.)

AL 5088 (12-17-54) (REVISED) (REVISIONS: 12-17-54)

REVISIONS:

NO.	DATE	DESCRIPTION
1	12-17-54	REVISION 1
2	12-17-54	REVISION 2
3	12-17-54	REVISION 3
4	12-17-54	REVISION 4
5	12-17-54	REVISION 5
6	12-17-54	REVISION 6
7	12-17-54	REVISION 7
8	12-17-54	REVISION 8
9	12-17-54	REVISION 9
10	12-17-54	REVISION 10
11	12-17-54	REVISION 11
12	12-17-54	REVISION 12

© AMETEK INC. 1966.12





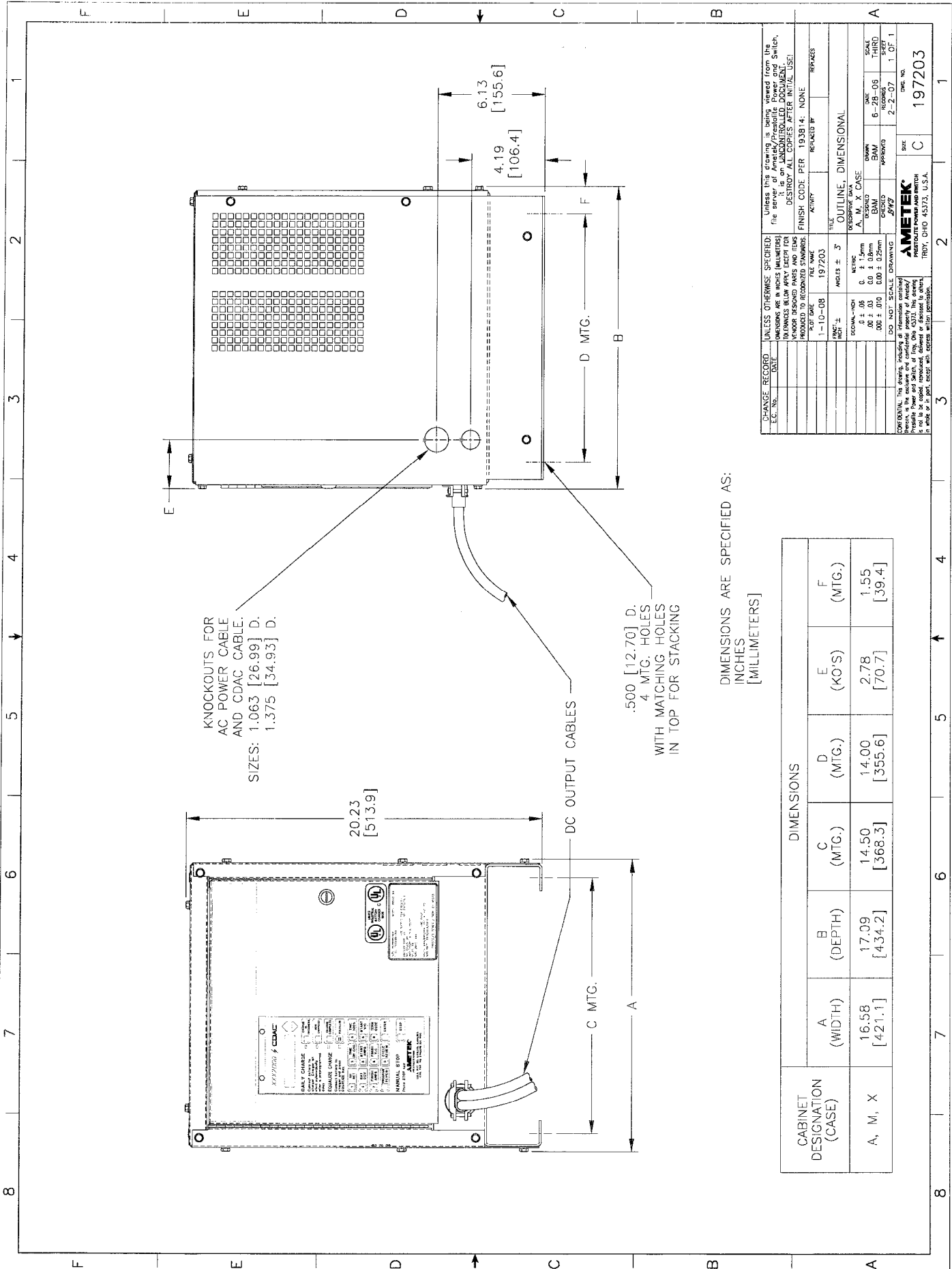

DIMENSIONS ARE SPECIFIED AS:  
 INCHES  
 [MILLIMETERS]

CABINET DESIGNATION (CASE)	DIMENSIONS				
	A (WIDTH)	B (DEPTH)	C (MTG.)	D (MTG.)	F (MTG.)
A, M, X	16.58 [421.1]	17.09 [434.2]	14.50 [368.3]	14.00 [355.6]	1.55 [39.4]
				2.78 [70.7]	

CHANGE RECORD	UNLESS OTHERWISE SPECIFIED: DIMENSIONS ARE IN INCHES (MILLIMETERS) UNLESS OTHERWISE NOTED. PRODUCE TO RECOGNIZED STANDARDS.	FILE NAME	197203	THIS ACTIVITY	REPLACES
E.C. No.		PLOT DATE	1-10-08		
		SCALE	AS SHOWN		
		UNIT	INCHES		
		PROJ. NO.	197203		
		REV. NO.	3		
		DESIGNED BY	A. M. X		
		DRAWN BY	AMX		
		CHECKED BY	AMX		
		DATE	6-28-06		
		SCALE	THIRD		
		REV. NO.	1 OF 1		
		DATE	2-2-07		
		SCALE	1 OF 1		
		DATE	6-28-06		
		SCALE	THIRD		
		REV. NO.	1 OF 1		
		DATE	2-2-07		
		SCALE	1 OF 1		
		DATE	6-28-06		
		SCALE	THIRD		
		REV. NO.	1 OF 1		
		DATE	2-2-07		
		SCALE	1 OF 1		
		DATE	6-28-06		
		SCALE	THIRD		
		REV. NO.	1 OF 1		
		DATE	2-2-07		
		SCALE	1 OF 1		
		DATE	6-28-06		
		SCALE	THIRD		
		REV. NO.	1 OF 1		
		DATE	2-2-07		
		SCALE	1 OF 1		
		DATE	6-28-06		
		SCALE	THIRD		
		REV. NO.	1 OF 1		
		DATE	2-2-07		
		SCALE	1 OF 1		
		DATE	6-28-06		
		SCALE	THIRD		
		REV. NO.	1 OF 1		
		DATE	2-2-07		
		SCALE	1 OF 1		
		DATE	6-28-06		
		SCALE	THIRD		
		REV. NO.	1 OF 1		
		DATE	2-2-07		
		SCALE	1 OF 1		
		DATE	6-28-06		
		SCALE	THIRD		
		REV. NO.	1 OF 1		
		DATE	2-2-07		
		SCALE	1 OF 1		
		DATE	6-28-06		
		SCALE	THIRD		
		REV. NO.	1 OF 1		
		DATE	2-2-07		
		SCALE	1 OF 1		
		DATE	6-28-06		
		SCALE	THIRD		
		REV. NO.	1 OF 1		
		DATE	2-2-07		
		SCALE	1 OF 1		
		DATE	6-28-06		
		SCALE	THIRD		
		REV. NO.	1 OF 1		
		DATE	2-2-07		
		SCALE	1 OF 1		
		DATE	6-28-06		
		SCALE	THIRD		
		REV. NO.	1 OF 1		
		DATE	2-2-07		
		SCALE	1 OF 1		
		DATE	6-28-06		
		SCALE	THIRD		
		REV. NO.	1 OF 1		
		DATE	2-2-07		
		SCALE	1 OF 1		
		DATE	6-28-06		
		SCALE	THIRD		
		REV. NO.	1 OF 1		
		DATE	2-2-07		
		SCALE	1 OF 1		
		DATE	6-28-06		
		SCALE	THIRD		
		REV. NO.	1 OF 1		
		DATE	2-2-07		
		SCALE	1 OF 1		
		DATE	6-28-06		
		SCALE	THIRD		
		REV. NO.	1 OF 1		
		DATE	2-2-07		
		SCALE	1 OF 1		
		DATE	6-28-06		
		SCALE	THIRD		
		REV. NO.	1 OF 1		
		DATE	2-2-07		
		SCALE	1 OF 1		
		DATE	6-28-06		
		SCALE	THIRD		
		REV. NO.	1 OF 1		
		DATE	2-2-07		
		SCALE	1 OF 1		
		DATE	6-28-06		
		SCALE	THIRD		
		REV. NO.	1 OF 1		
		DATE	2-2-07		
		SCALE	1 OF 1		
		DATE	6-28-06		
		SCALE	THIRD		
		REV. NO.	1 OF 1		
		DATE	2-2-07		
		SCALE	1 OF 1		
		DATE	6-28-06		
		SCALE	THIRD		
		REV. NO.	1 OF 1		
		DATE	2-2-07		
		SCALE	1 OF 1		
		DATE	6-28-06		
		SCALE	THIRD		
		REV. NO.	1 OF 1		
		DATE	2-2-07		
		SCALE	1 OF 1		
		DATE	6-28-06		
		SCALE	THIRD		
		REV. NO.	1 OF 1		
		DATE	2-2-07		
		SCALE	1 OF 1		
		DATE	6-28-06		
		SCALE	THIRD		
		REV. NO.	1 OF 1		
		DATE	2-2-07		
		SCALE	1 OF 1		
		DATE	6-28-06		
		SCALE	THIRD		
		REV. NO.	1 OF 1		
		DATE	2-2-07		
		SCALE	1 OF 1		
		DATE	6-28-06		
		SCALE	THIRD		
		REV. NO.	1 OF 1		
		DATE	2-2-07		
		SCALE	1 OF 1		
		DATE	6-28-06		
		SCALE	THIRD		
		REV. NO.	1 OF 1		
		DATE	2-2-07		
		SCALE	1 OF 1		
		DATE	6-28-06		
		SCALE	THIRD		
		REV. NO.	1 OF 1		
		DATE	2-2-07		
		SCALE	1 OF 1		
		DATE	6-28-06		
		SCALE	THIRD		
		REV. NO.	1 OF 1		
		DATE	2-2-07		
		SCALE	1 OF 1		
		DATE	6-28-06		
		SCALE	THIRD		
		REV. NO.	1 OF 1		
		DATE	2-2-07		
		SCALE	1 OF 1		
		DATE	6-28-06		
		SCALE	THIRD		
		REV. NO.	1 OF 1		
		DATE	2-2-07		
		SCALE	1 OF 1		
		DATE	6-28-06		
		SCALE	THIRD		
		REV. NO.	1 OF 1		
		DATE	2-2-07		
		SCALE	1 OF 1		
		DATE	6-28-06		
		SCALE	THIRD		
		REV. NO.	1 OF 1		
		DATE	2-2-07		
		SCALE	1 OF 1		
		DATE	6-28-06		
		SCALE	THIRD		
		REV. NO.	1 OF 1		
		DATE	2-2-07		
		SCALE	1 OF 1		
		DATE	6-28-06		
		SCALE	THIRD		
		REV. NO.	1 OF 1		
		DATE	2-2-07		
		SCALE	1 OF 1		
		DATE	6-28-06		
		SCALE	THIRD		
		REV. NO.	1 OF 1		
		DATE	2-2-07		
		SCALE	1 OF 1		
		DATE	6-28-06		
		SCALE	THIRD		
		REV. NO.	1 OF 1		
		DATE	2-2-07		
		SCALE	1 OF 1		
		DATE	6-28-06		
		SCALE	THIRD		
		REV. NO.	1 OF 1		
		DATE	2-2-07		
		SCALE	1 OF 1		
		DATE	6-28-06		
		SCALE	THIRD		
		REV. NO.	1 OF 1		
		DATE	2-2-07		
		SCALE	1 OF 1		
		DATE	6-28-06		
		SCALE	THIRD		
		REV. NO.	1 OF 1		
		DATE	2-2-07		
		SCALE	1 OF 1		
		DATE	6-28-06		
		SCALE	THIRD		
		REV. NO.	1 OF 1		
		DATE	2-2-07		
		SCALE	1 OF 1		
		DATE	6-28-06		
		SCALE	THIRD		
		REV. NO.	1 OF 1		
		DATE	2-2-07		
		SCALE	1 OF 1		
		DATE	6-28-06		
		SCALE	THIRD		
		REV. NO.	1 OF 1		
		DATE	2-2-07		
		SCALE	1 OF 1		
		DATE	6-28-06		
		SCALE	THIRD		
		REV. NO.	1 OF 1		
		DATE	2-2-07		
		SCALE	1 OF 1		
		DATE	6-28-06		
		SCALE	THIRD		
		REV. NO.	1 OF 1		
		DATE	2-2-07		
		SCALE	1 OF 1		
		DATE	6-28-06		
		SCALE	THIRD		
		REV. NO.	1 OF 1		
		DATE	2-2-07		
		SCALE	1 OF 1		
		DATE	6-28-06		
		SCALE	THIRD		
		REV. NO.	1 OF 1		
		DATE	2-2-07		
		SCALE	1 OF 1		





# WARRANTY

## AMETEK/PRESTOLITE POWER “FERRORESONANT” INDUSTRIAL BATTERY CHARGERS

Ametek/Prestolite Power (hereinafter called “Prestolite”) warrants that each new and unused Industrial Battery Charger manufactured and supplied by it is of good workmanship and is free from any inherent mechanical defects, provided that (1) the product is installed and operated in accordance with generally accepted industrial standards and in accordance with the printed instructions of Prestolite, (2) the product is used under normal conditions for which designed, (3) the product is not subjected to misuse, negligence or accident, and (4) the product receives proper care, protection and maintenance under supervision of competent personnel. This warranty is subject to the following provisions:

1. **PRODUCT AND PARTS WARRANTED.** Subject to the exceptions listed below each Industrial Battery Charger is warranted for a specific period of time commencing from the date of it’s shipment by Prestolite, provided the charger is used in accordance with Prestolite’s published performance rating for the unit involved. The exceptions to this warranty are as follows:

a) Terms and conditions for warranty coverage:

<u>FERRORESONANT PRODUCTS</u>	ACCU CHARGER	BATTERY MATE 100	BATTERY MATE 80	BATTERY MATE 60
FULL COVERAGE - LABOR, TRAVEL, MILEAGE & PART REPLACEMENT	10-year "full"	10-year "full"	1-year	1-year
PRINTED CIRCUIT BOARD (REPLACEMENT ONLY)				
TRANSFORMER, INDUCTOR, SCR & DIODE (REPLACEMENT ONLY)			9-years additional	9-years additional
TOTAL WARRANTY TERM (YEARS)	10-years	10-years	10-years	10-years

b) Warranty Expense Limitation: The maximum warranty expense Prestolite will incur for any Battery Charger will be limited to the original purchase price of the Battery Charger.

c) Primary switch contacts, fuses, bulbs and filters are not warranted unless found to be defective prior to use.

2. **COMMENCEMENT OF WARRANTY TIME PERIODS.** The warranty periods indicated in the Warranty Schedule shall commence on the date of shipment by Prestolite. The ACCU CHARGER and BATTERY MATE 100, 10-year full warranty only applies to chargers manufactured after the 4<sup>th</sup> quarter of 2004. Units manufactured previous to the 4<sup>th</sup> quarter will have 1-year full, plus 9-years parts limited coverage.
3. **PERSONS COVERED BY WARRANTY.** Prestolite extends this warranty only to the purchaser of new equipment from Prestolite or one of its authorized distributors. The products purchased under this agreement shall be used exclusively by the buyer and its employees and by no other persons; and therefore there shall be no third party beneficiary to this warranty.
4. **LIMITATION OF REMEDY.** The existence of claimed defects in any product covered by this warranty is subject to Prestolite’s factory inspection and judgement. Prestolite’s liability is limited to repair of any defects found by Prestolite to exist or, at Prestolite’s option, the replacement of the defective product F.O.B. factory after the defective product has been returned by the purchaser at its expense to Prestolite’s shipping place. Replacement and exchange parts will be warranted for the remainder of the original Industrial Battery Charger Warranty or for a period of ninety (90) days, whichever is greater.
5. **USE OF DEFECTIVE PRODUCT.** Continued use of an Industrial Battery Charger after discovery of a defect VOIDS ALL WARRANTIES.
6. **ALTERED EQUIPMENT.** Except as authorized in writing, the warranty specified does not cover any equipment that has been altered by any party other than Prestolite.

**THIS WARRANTY IS GIVEN AND ACCEPTED IN LIEU OF ALL OTHER WARRANTIES, WHETHER EXPRESS OR IMPLIED, INCLUDING WITHOUT LIMITATION ANY WARRANTIES OF MERCHANTABILITY OR FITNESS FOR A PARTICULAR PURPOSE, OTHER THAN AS EXPRESSLY SET FORTH HEREIN. IN NO EVENT SHALL PRESTOLITE BE LIABLE FOR ANY ANTICIPATED OR LOST PROFITS, SPECIAL, DIRECT, INDIRECT OR INCIDENTAL DAMAGES, CONSEQUENTIAL DAMAGES, TIME CHARGES OR OTHER COMMERCIAL EXPENSES OR LOSSES, AND BUYER ASSUMES ALL RISK AND LIABILITY RESULTING FROM USE OF THE GOODS. PRESTOLITE DOES NOT AUTHORIZE ANY REPRESENTATIVE OR OTHER PERSON TO ASSUME ON BEHALF OF PRESTOLITE ANY OTHER LIABILITY IN CONNECTION WITH THE SALE OR USE OF THE GOODS SOLD, AND THERE ARE NO ORAL AGREEMENTS OR WARRANTIES COLLATERAL TO OR AFFECTING THIS WRITTEN WARRANTY.**

### WARNING

At all times, safety must be considered an important factor in the installation, servicing and operation of the product and skilled, qualified technical assistance should be utilized.

**AMETEK/PRESTOLITE POWER - TROY, OHIO USA**

Data Sheet: 1153  
 Index: 030105  
 Replaces: Original